

**zafferano**  
LAMPES-À-PORTER

# E se fosse una lampada a illuminare l'inaspettato?

What if a lamp  
could light up the unexpected?

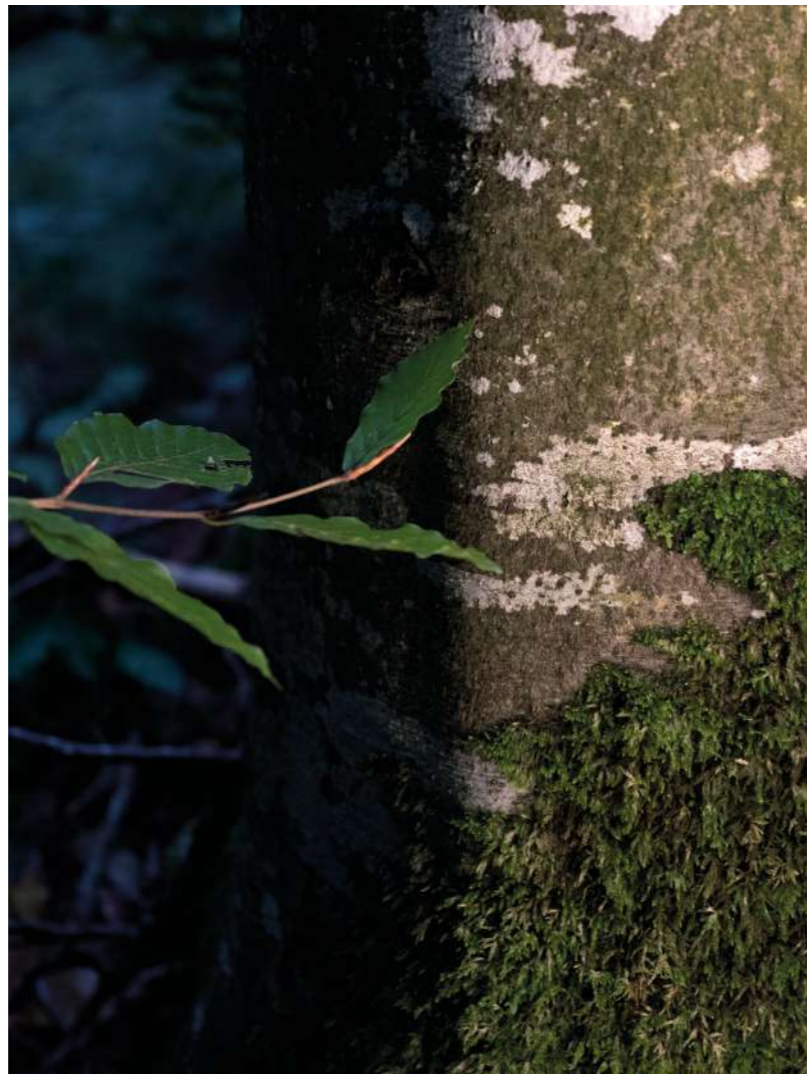











Questo che vi proponiamo  
è un breve viaggio nella natura  
natura protagonista con la sua intatta bellezza.  
Lampade che fanno da contrappunto a questi paesaggi  
accoglienti e disponibili  
offrono luoghi inaspettati, inconsueti  
dove la luce, compagna fedele,  
fa riscoprire colori e profili  
che i tramonti vanno via via dileguando  
inghiottiti dall'oscurità.



What we propose  
is a short journey into nature.  
With its unspoilt beauty, nature is the protagonist.  
Lamps bring a contrast to these  
welcoming and receptive landscapes.  
They offer unexpected and unusual places,  
where light, a faithful companion,  
lets you rediscover colours and profiles  
that sunsets gradually fade away  
swallowed by darkness.



# Indice delle collezioni

## Collections overview

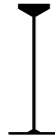
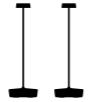



								
06	12	24	28	32	36	40	44	48
<b>Poldina</b>	Tavolo Table lamp	Mini tavolo Mini table lamp	Micro tavolo Micro table lamp	L terra-tavolo L floor-table lamp	XXL terra-tavolo XXL floor-table lamp	Picchetto Lamp with peg	Sospensione Suspension lamp	Parete Wall lamp







								
52	56	60		64	68			
<b>Olivia</b>	Tavolo Table lamp	Mini tavolo Mini table lamp		<b>Ofelia</b>	Tavolo Table lamp			



								
72	76	80		84	86	90	94	
<b>Pina</b>	Tavolo Table lamp	Supporto da terra Floor stand		<b>Swap</b>	Tavolo Table lamp	Paralumi Lampshades	Mini tavolo Mini table lamp	

								
98	100		104	108				
<b>Home</b>	Tavolo Table lamp		<b>Dama</b>	Tavolo USB Table lamp USB				

								
112	116							
<b>Olimpia</b>	Tavolo Table lamp							

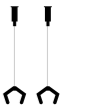
								
120	124	128	132	134	138			
<b>Sister Light</b>	Tavolo Table lamp	Mini tavolo Mini table lamp	Bowl / piatto Bowl / plate	Picchetto Lamp with peg	Parete Wall lamp			

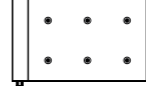
								
142	146	152	156	158	160	162	166	
<b>Pencil</b>	Modulo luminoso con accessori Lighting module with accessories							

								
168	168	170	172	174				
<b>Accessori</b> Accessories	Basi di ricarica e caricatori Charging bases and chargers	Basi di ricarica multipla Multi-contact charging base	Batterie Battery packs	Cover Poldina Poldina cover				<b>175</b> Stand e personalizzazioni Stand and customization

# Poldina

Sembri nata dalle terre umide  
mentre la vicina laguna  
risplende del finire del sole.  
Piccola, illumini  
in un contrasto concreto e voluto  
gli arbusti selvaggi e profumati.

You appear to have come from the wetlands  
while the nearby lagoon  
glows in the setting sun.  
Little one, you illuminate  
with a distinct, intentional contrast  
wild and fragrant shrubs.

TAVOLO / MINI TAVOLO / MICRO TAVOLO / L TERRA-TAVOLO / XXL TERRA-TAVOLO / PICCHETTO / SOSPENSIONE / PARETE  
TABLE LAMP / MINI TABLE LAMP / MICRO TABLE LAMP / L FLOOR-TABLE LAMP / XXL FLOOR-TABLE LAMP / LAMP WITH PEG /  
SUSPENSION LAMP / WALL LAMP



Poldina lamp with peg white  
→ **LD0282B3**  
Porto Caleri  
Rovigo, Italy



Previous page:  
Poldina table lamp white → **LD0340B3**  
Poldina table lamp dark grey → **LD0340N3**

Current page:  
Poldina mini table  
lamp dark grey → **LD0320N3**





Current page: Poldina mini table  
lamp dark grey → **LD0320N3**  
Caffè Doria - Roma, Italy  
Photo Andrea Di Lorenzo

Next page: Poldina mini  
table lamp white → **LD0320B3**  
Gran Caffè Quadri, Piazza San Marco  
Venice, Italy  
Photo Maurizio Torresan Photographer

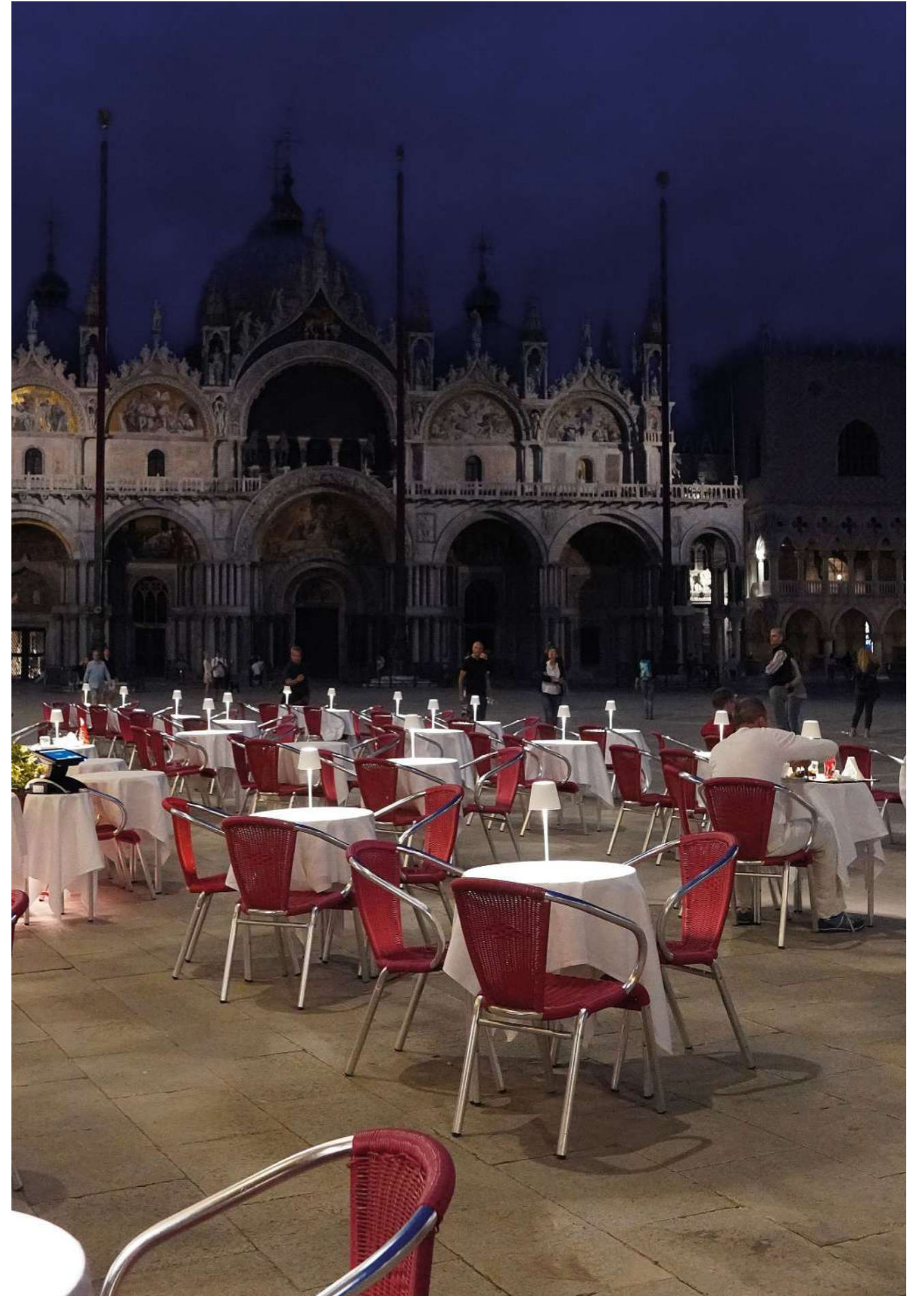

# Poldina

## Tavolo pro Table lamp pro



Poldina è una lampada a batteria portatile e ricaricabile da tavolo. È dotata di base di ricarica a contatto, touch dimmer. La lampada è dotata inoltre della funzione di selezione della temperatura di colore della luce tra 2700K e 3000K (bianco dinamico).

Poldina is a battery-operated portable and rechargeable table lamp. It is equipped with contact charging base and dimmer touch control. The lamp is equipped also with a light color temperature selection function 2700K or 3000K (dynamic white).

### Dati tecnici Technical data

LED DIMMER • 2,2W • 192-200lm  
2700-3000K • IP65 • CRI>80  
100-240V • 50-60Hz • 5Vdc max 1A



Pacco batteria al litio ricaricabile e sostituibile  
Rechargeable and replaceable lithium battery pack

Durata di circa 12 h alla massima potenza  
Battery lasts about 12 h at full power

Tempo di ricarica a 1A: 6-7 h  
Charging time at 1A: 6-7 h

Corpo in pressofusione di alluminio verniciato  
Painted die-cast aluminium fixture

Diffusore in policarbonato  
Polycarbonate diffuser

Adatta all'uso esterno (lampada IP65) e interno  
(lampada su base di ricarica IP20) → legenda pag. 178  
Suitable for outdoor (lamp IP65) and indoor use  
(lamp on charging base IP20) → legend pg. 178

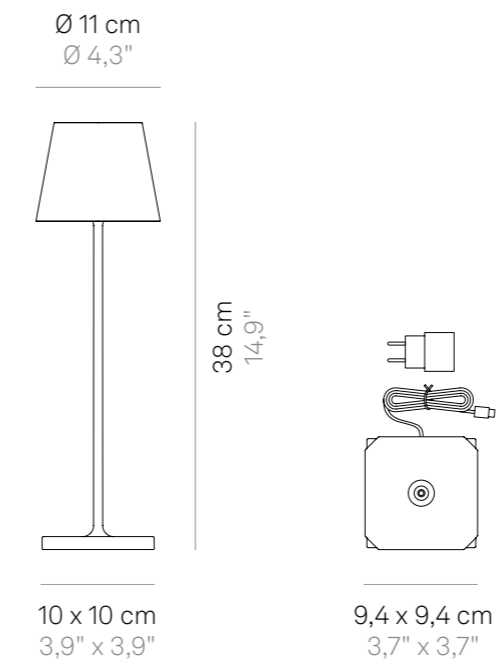

### Accessori inclusi Accessories included

Base di ricarica a contatto  
Contact charging base

### Avvertenze Remarks

Le lampade con finitura foglia color oro, foglia color argento e foglia color rame e con finitura galvanica lucida oro e cromo non sono adatte per uso esterno. The lamps with gold color leaf, silver color leaf and copper color leaf finish and with gold and chrome glossy galvanic finish are not suitable for outdoor use.

**Finiture**  
Finishes



**LD0340B3**  
Bianco  
White  
RAL 9002

**LD0340R3**  
Corten

**LD0340N3**  
Grigio scuro  
Dark grey  
RAL 7012

**LD0340S3**  
Sabbia  
Sand  
RAL 1014

**Finiture**  
Finishes



**LD0340A3**  
Blu avio  
Avio Blue  
Pantone 7468U

**LD0340M3**  
Verde scuro  
Dark green  
RAL 6005

**LD0340G3**  
Salvia  
Sage green  
Pantone 5635U

**LD0340P3**  
Rosa  
Pink  
Pantone 698U



**LD0340F3**  
Rosso  
Red  
RAL 3000

**LD0340X3**  
Bordeaux  
Burgundy  
RAL 3005

**LD0340O3**  
Oro lucido  
Glossy gold  
Galvanic finish

**LD0340C3**  
Cromo lucido  
Glossy chrome  
Galvanic finish



**LD0340BFO**  
Foglia color oro  
Gold color leaf

**LD0340BFA**  
Foglia color argento  
Silver color leaf

**LD0340RFR**  
Foglia color rame  
Copper color leaf

Le lampade con finitura galvanica lucida oro e cromo non sono adatte per uso esterno.  
The lamps with gold and chrome glossy galvanic finish are not suitable for outdoor use.

Le lampade con finitura foglia color oro, foglia color argento e foglia color rame non sono adatte per uso esterno.  
The lamps with gold color leaf, silver color leaf and copper color leaf finish are not suitable for outdoor use.



# Poldina Lido

ceramica fatta a mano  
handmade ceramic

## Tavolo pro

Table lamp pro



Poldina Lido è una lampada a batteria portatile e ricaricabile da tavolo, caratterizzata da una cover del paralume in ceramica, prodotto e dipinto a mano in Italia.

La collaborazione con un'antica fabbrica di Civita Castellana - borgo viterbese dove l'arte della ceramica è attestata fin dal X secolo a.C. - permette a Zafferano di contare su una produzione in esclusiva di prodotti made in Italy, decorati a mano su proprio disegno.

Poldina Lido is a battery-operated, portable and rechargeable table lamp, featuring a ceramic lampshade cover, made and hand-painted in Italy.

The partnership with a long-established factory in Civita Castellana - a village near Rome, where the art of ceramics has been practised since the 10th century BC - allows Zafferano to rely on the exclusive manufacture of made in Italy products, which are hand-decorated according to the company's own design.



Poldina Lido table lamp avio blue /  
Light blue fish → **LD0340AC1**

**Dati tecnici**

## Technical data

LED DIMMER • 2,2W • 192-200lm  
 2700-3000K • IP65 • CRI>80  
 100-240V • 50-60Hz • 5Vdc max 1A

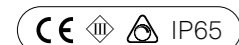

Pacco batteria al litio ricaricabile e sostituibile  
 Rechargeable and replaceable lithium battery pack

Durata di circa 12 h alla massima potenza  
 Battery lasts about 12 h at full power

Tempo di ricarica a 1A: 6-7 h  
 Charging time at 1A: 6-7 h

Corpo in pressofusione di alluminio verniciato  
 Painted die-cast aluminium fixture

Diffusore in policarbonato  
 Polycarbonate diffuser

Ø 13 cm  
 Ø 5,1"

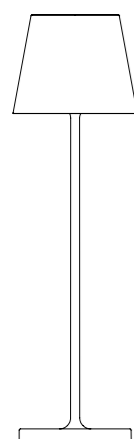

38 cm  
 14,9"

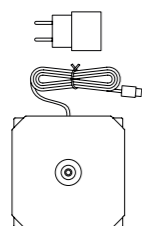

10 x 10 cm  
 3,9" x 3,9"

9,4 x 9,4 cm  
 3,7" x 3,7"

**Accessori inclusi**

Accessories included

Base di ricarica a contatto  
 Contact charging base

**Avvertenze**

Remarks

Cover acquistabile anche separatamente (pag. 174)  
 Cover can also be purchased separately (pg. 174)

**Finiture**

## Finishes

**LD0340BC1**

Bianco / Righe verdi  
 White / Green stripes  
 RAL 9002

**LD0340BC2**

Bianco / Righe gialle  
 White / Yellow stripes  
 RAL 9002

**LD0340BC3**

Bianco / Righe blu  
 White / Blue stripes  
 RAL 9002

**LD0340FC1**

Rosso / Righe rosse  
 Red / Red stripes  
 RAL 3000

**LD0340AC1**

Blu avio / Pesci azzurri  
 Avio blue / Light blue fish  
 Pantone 7468U

**poldina** x PEANUTS

**Tavolo pro**  
Table lamp pro

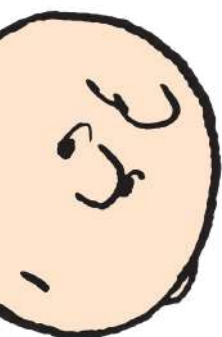

Poldina x Peanuts è una lampada a batteria portatile e ricaricabile da tavolo, personalizzata con i personaggi creati da Charles Schulz.

Peanuts, la striscia creata da Charles Schulz e pubblicata dal 1950, è uno dei fumetti più conosciuti al mondo. Poetici, teneri e ironici, i suoi personaggi sono figure classiche e senza tempo, in cui ogni lettore può riconoscersi.

Poldina x Peanuts is a battery-operated portable and rechargeable table lamp, customized with characters created by Charles Schulz.

Peanuts, created by Charles Schulz and first published in 1950, is one of the best-known comic strips in the world. Each member of the Peanuts gang is a classic, timeless figure with whom every reader can identify.

Poldina x Peanuts table lamp  
Aviator → **LD0340FP1**



**Dati tecnici**

Technical data

LED DIMMER • 2,2W • 192-200lm  
 2700-3000K • IP65 • CRI>80  
 100-240V • 50-60Hz • 5Vdc max 1A

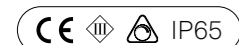

Pacco batteria al litio ricaricabile e sostituibile  
 Rechargeable and replaceable lithium battery pack

Durata di circa 12 h alla massima potenza  
 Battery lasts about 12 h at full power

Tempo di ricarica a 1A: 6-7 h  
 Charging time at 1A: 6-7 h

Corpo in pressofusione di alluminio verniciato  
 Painted die-cast aluminium fixture

Diffusore in policarbonato  
 Polycarbonate diffuser

Adatta all'uso esterno (lampada IP65) e interno  
 (lampada su base di ricarica IP20) → legenda pag. 178  
 Suitable for outdoor (lamp IP65) and indoor use  
 (lamp on charging base IP20) → legend pg. 178

Ø 11 cm  
 Ø 4,3"

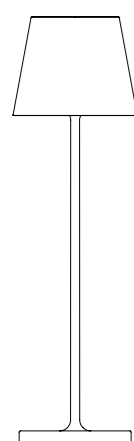

38 cm  
 14,9"

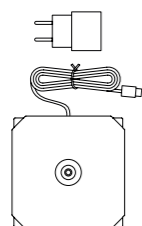

10 x 10 cm  
 3,9" x 3,9"

9,4 x 9,4 cm  
 3,7" x 3,7"

**Finiture**

Finishes



**LD0340FP1**  
 Aviator  
 RAL 3000



**LD0340BP2**  
 Heart  
 RAL 9002



**LD0340BP3**  
 Friends  
 RAL 9002



**LD0340BP4**  
 Strip  
 RAL 9002



**LD0340RP5**  
 Together

**Accessori inclusi**

Accessories included

Base di ricarica a contatto  
 Contact charging base



# Poldina mini

## Tavolo pro Table lamp pro



### Dati tecnici Technical data

LED DIMMER • 2,2W • 192-200lm  
2700-3000K • IP65 • CRI>80  
100-240V • 50-60Hz • 5Vdc max 1A



Pacco batteria al litio ricaricabile e sostituibile  
Rechargeable and replaceable lithium battery pack

Durata di circa 12 h alla massima potenza  
Battery lasts about 12 h at full power

Tempo di ricarica a 1A: 6-7 h  
Charging time at 1A: 6-7 h

Corpo in pressofusione di alluminio verniciato  
Painted die-cast aluminium fixture

Diffusore in policarbonato  
Polycarbonate diffuser

Adatta all'uso esterno (lampada IP65) e interno  
(lampada su base di ricarica IP20) → legenda pag. 178  
Suitable for outdoor (lamp IP65) and indoor use  
(lamp on charging base IP20) → legend pg. 178

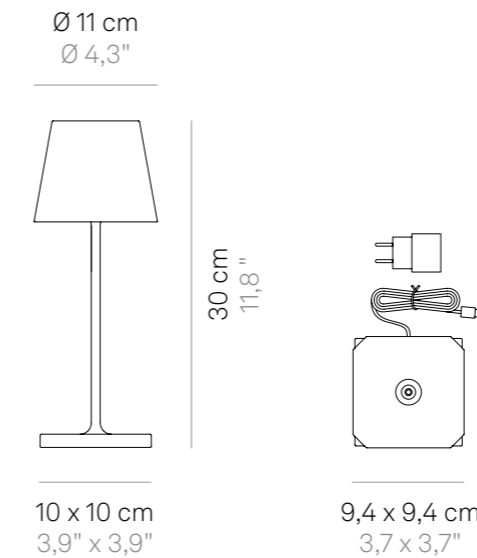

Poldina mini è una lampada a batteria portatile e ricaricabile da tavolo. È dotata di base di ricarica a contatto, touch dimmer. La lampada è dotata inoltre della funzione di selezione della temperatura di colore della luce tra 2700K e 3000K (bianco dinamico).

Poldina mini is a battery-operated portable and rechargeable table lamp. It is equipped with contact charging base and dimmer touch control. The lamp is equipped also with a light color temperature selection function, 2700K or 3000K (dynamic white).

### Accessori inclusi Accessories included

Base di ricarica a contatto  
Contact charging base

### Avvertenze Remarks

Le lampade con finitura foglia color oro, foglia color argento e foglia color rame e con finitura galvanica lucida oro e cromo non sono adatte per uso esterno. The lamps with gold color leaf, silver color leaf and copper color leaf finish and with gold and chrome glossy galvanic finish are not suitable for outdoor use.

**Finiture**  
Finishes



**LD0320B3**  
Bianco  
White  
RAL 9002

**LD0320R3**  
Corten

**LD0320N3**  
Grigio scuro  
Dark grey  
RAL 7012

**LD0320S3**  
Sabbia  
Sand  
RAL 1014

**Finiture**  
Finishes



**LD0320BFO**  
Foglia color oro  
Gold color leaf

**LD0320BFA**  
Foglia color argento  
Silver color leaf

**LD0320RFR**  
Foglia color rame  
Copper color leaf



**LD0320O3**  
Oro lucido  
Glossy gold  
Galvanic finish

**LD0320C3**  
Cromo lucido  
Glossy chrome  
Galvanic finish

Le lampade con finitura foglia color oro, foglia color argento e foglia color rame e con finitura galvanica lucida oro e cromo non sono adatte per uso esterno. The lamps with gold color leaf, silver color leaf and copper color leaf finish and with gold and chrome glossy galvanic finish are not suitable for outdoor use.

# Poldina micro NEW

## Tavolo pro Table lamp pro



### Dati tecnici Technical data

LED DIMMER • 1,8W • 124-128-142lm  
2200-2700-3000K • IP65 • CRI>80  
100-240V • 50-60Hz • 5Vdc max 1A



Pacco batteria al litio ricaricabile e sostituibile  
Rechargeable and replaceable lithium battery pack

Durata di 7-8 h alla massima potenza  
Battery lasts 7-8 h at full power

Tempo di ricarica a 1A: 3-4 h  
Charging time at 1A: 3-4 h

Corpo in pressofusione di alluminio  
Die-cast aluminium fixture

Diffusore in policarbonato  
Polycarbonate diffuser

Adatta all'uso esterno (lampada IP65) e interno  
(lampada su base di ricarica IP20) → legenda pag. 178  
Suitable for outdoor (lamp IP65) and indoor use  
(lamp on charging base IP20) → legend pg. 178

Resistenza alla nebbia salina (500h)  
Salt spray resistant (500h)

Ø 7 cm  
Ø 2,8"



7 x 7 cm  
2,8" x 2,8"

27,5 cm  
10,8"

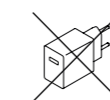

non incluso  
not included

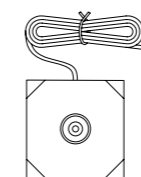

6,7 x 6,7 cm  
2,6" x 2,6"

### Avvertenze Remarks

Le lampade con finitura galvanica lucida oro e cromo non sono adatte per uso esterno.  
The lamps with gold and chrome glossy galvanic finish are not suitable for outdoor use.

Poldina micro è una lampada a batteria portatile e ricaricabile da tavolo dotata di base di ricarica a contatto, touch dimmer e funzione di selezione della temperatura di colore della luce tra 2200K, 2700K e 3000K (bianco dinamico).

Poldina micro is a battery-operated portable and rechargeable table lamp. It is equipped with contact charging base, dimmer touch control and light color temperature selection function, 2200K, 2700K or 3000K (dynamic white).

### Accessori inclusi Accessories included

Base di ricarica a contatto  
Contact charging base

### Accessori non inclusi Accessories not included

Caricatore  
Charger

**Finiture**  
Finishes



**LD0490B3**  
Bianco  
White  
RAL 9002



**LD0490R3**  
Corten



**LD0490N3**  
Grigio scuro  
Dark grey  
RAL 7012



**LD0490D3**  
Nero  
Black  
RAL 9005



**LD0490G3**  
Salvia  
Sage green  
Pantone 5635U



**LD0490P3**  
Rosa  
Pink  
Pantone 698U



**LD0490F3**  
Rosso  
Red  
RAL 3000



**LD0490S3**  
Sabbia  
Sand  
RAL 1014

**Finiture**  
Finishes



**LD0490L3**  
Lilla  
Lilac  
RAL 4005



**LD0490K3**  
Blu Capri  
Capri blue  
RAL 5019



**LD0490V3**  
Verde mela  
Apple green  
RAL 6018



**LD0490Z3**  
Arancio  
Orange  
RAL 2008



**LD0490O3**  
Oro lucido  
Glossy gold  
Galvanic finish



**LD0490C3**  
Cromo lucido  
Glossy chrome  
Galvanic finish

Le lampade con finitura galvanica lucida oro e cromo non sono adatte per uso esterno.  
The lamps with gold and chrome glossy galvanic finish are not suitable for outdoor use.



# Poldina L

## Tavolo-terra pro Floor-table lamp pro



Poldina L floor-table lamp  
white → **LD0390B3**



Poldina L è una lampada a batteria portatile e ricaricabile da terra e da tavolo. È dotata di base di ricarica a contatto, touch dimmer, funzione di selezione della temperatura di colore della luce tra 2700K e 3000K (bianco dinamico) e di un kit di 3 aste che permette di regolare l'altezza della lampada da un minimo di 52 a un massimo di 122 cm.

Poldina L is a battery-operated portable and rechargeable floor and table lamp. It is equipped with contact charging base, dimmer touch control, light colour temperature selection function, 2700K or 3000K (dynamic white) and a 3-rod kit that allows you to adjust the height of the lamp from minimum 52 cm to maximum 122 cm.

**Dati tecnici**

## Technical data

LED DIMMER • 4,5W • 370-400lm  
 2700-3000K • IP54 • CRI>80  
 100-240V • 50-60Hz • 5Vdc max 1A

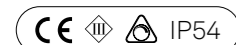

Pacchi batterie al litio ricaricabili e sostituibili  
 Rechargeable and replaceable lithium battery packs

Durata di circa 11 h alla massima potenza  
 Battery lasts about 11 h at full power

Tempo di ricarica a 1A: circa 11 h  
 Charging time at 1A: about 11 h

Corpo in pressofusione di alluminio verniciato  
 Painted die-cast aluminium fixture

Diffusore in policarbonato  
 Polycarbonate diffuser

Adatta all'uso esterno (lampada IP54) e interno  
 (lampada su base di ricarica IP20) → legenda pag. 178  
 Suitable for outdoor (lamp IP54) and indoor use  
 (lamp on charging base IP20) → legend pg. 178

Ø 16,5 cm  
 Ø 6,5"

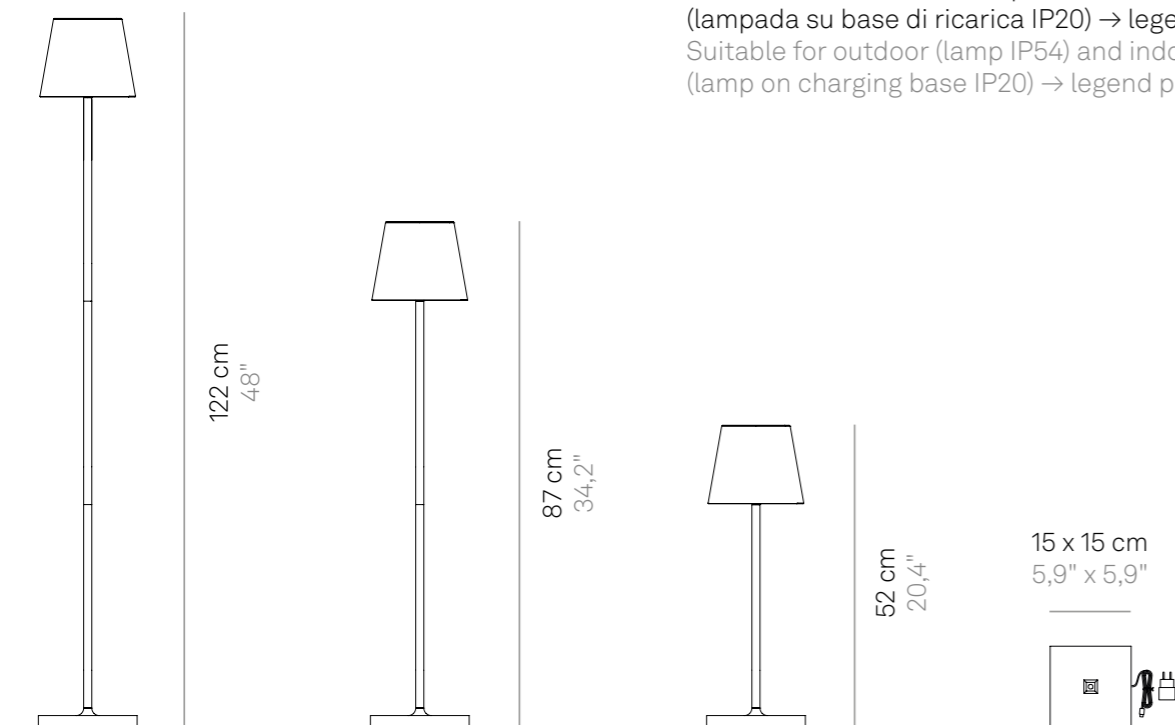

17 x 17 cm  
 6,6" x 6,6"

**Accessori inclusi**

Accessories included

Base di ricarica a contatto  
 Contact charging base

Kit di tre aste  
 3-rod kit

**Finiture**

## Finishes

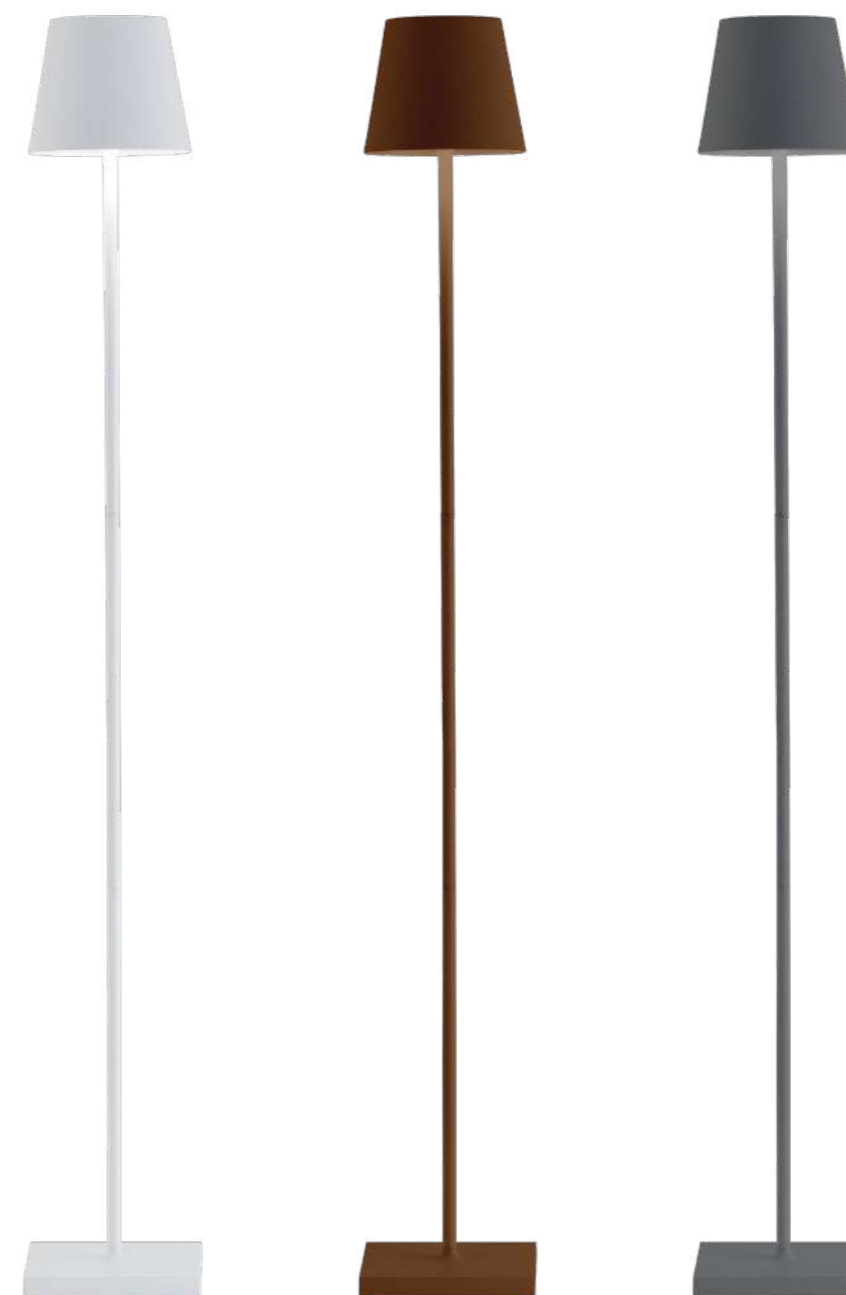

**LD0390B3**  
 Bianco  
 White  
 RAL 9002

**LD0390R3**  
 Corten

**LD0390N3**  
 Grigio scuro  
 Dark grey  
 RAL 7012

# Poldina XXL

**Tavolo-terra pro**  
Floor-table lamp pro



Poldina XXL è una lampada a batteria portatile e ricaricabile da terra e da tavolo. È dotata di base di ricarica a contatto, touch dimmer, funzione di selezione della temperatura di colore della luce tra 2700K e 3000K (bianco dinamico) e di un kit di 3 aste che permette di regolare l'altezza della lampada da un minimo di 69 cm a un massimo di 150 cm.

Poldina XXL is a battery-operated portable and rechargeable floor and table lamp. It is equipped with contact charging base, dimmer touch control, light colour temperature selection function, 2700K or 3000K (dynamic white) and a 3-rod kit that allows you to adjust the height of the lamp from minimum 69 cm to maximum 150 cm.



Poldina XXL floor-table lamp  
dark grey → **LD0360N3**

**Dati tecnici**

## Technical data

LED DIMMER • 10W • 460-510lm  
 2700-3000K • IP54 • CRI>80  
 100-240V • 50-60Hz • 5Vdc max 1A

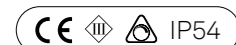

Ø 28 cm  
 Ø 11"

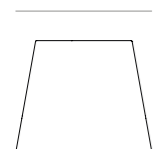

150 cm  
 59"

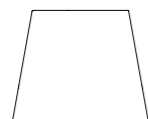

110 cm  
 43,3"

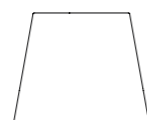

69,5 cm  
 27,3"

Ø 24,7 cm  
 Ø 9,7"



28 x 28 cm  
 11" x 11"

**Accessori inclusi**

Accessories included

Base di ricarica a contatto  
 Contact charging base

Kit di tre aste  
 3-rod kit

Pacchi batterie al litio ricaricabili e sostituibili  
 Rechargeable and replaceable lithium battery packs

Durata di circa 15 h alla massima potenza  
 Battery lasts about 15 h at full power

Tempo di ricarica a 1A: circa 20 h  
 Charging time at 1A: about 20 h

Corpo in pressofusione di alluminio verniciato  
 Painted die-cast aluminium fixture

Diffusore in policarbonato  
 Polycarbonate diffuser

Adatta all'uso esterno (lampada IP54) e interno  
 (lampada su base di ricarica IP20) → legenda pag. 178  
 Suitable for outdoor (lamp IP54) and indoor use  
 (lamp on charging base IP20) → legend pg. 178

**Finiture**

## Finishes



**LD0360B3**  
 Bianco  
 White  
 RAL 9002

**LD0360R3**  
 Corten

**LD0360N3**  
 Grigio scuro  
 Dark grey  
 RAL 7012

# Poldina

## Picchetto

Lamp with peg



Poldina lamp with peg white  
→ **LD0282B3**

Poldina picchetto è una lampada a batteria portatile e ricaricabile, dotata di touch dimmer. Disponibili come accessori: aste aggiuntive che permettono di aumentare l'altezza della lampada.

Poldina lamp with peg is a battery-operated portable and rechargeable lamp, equipped with dimmer touch control. Additional stem extensions are available as accessories to increase the height of the lamp.

**Dati tecnici**

## Technical data

LED DIMMER • 2,2W • 188lm  
 3000K • IP54 • CRI>80  
 100-240V • 50-60Hz • 5Vdc max 1A



Ø 11 cm  
 Ø 4,3"

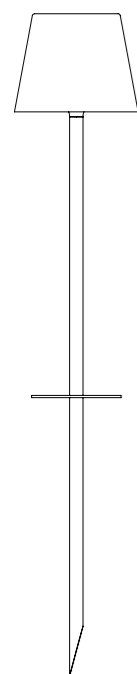

60 cm  
 23,6"

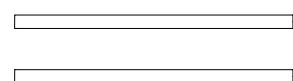
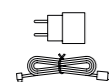

Ø 1,2 cm  
 Ø 0,4"

25 cm  
 9,8"

Pacco batteria al litio ricaricabile e sostituibile  
 Rechargeable and replaceable lithium battery pack

Durata di circa 9 h alla massima potenza  
 Battery lasts about 9 h at full power

Ricarica con cavo Micro-USB  
 Rechargeable with a Micro-USB cable

Tempo di ricarica a 1A: 6-8 h  
 Charging time at 1A: 6-8 h

Corpo in pressofusione di alluminio verniciato  
 Painted die-cast aluminium fixture

Diffusore in policarbonato  
 Polycarbonate diffuser

Adatta all'uso esterno (lampada IP54) e interno  
 (lampada su base di ricarica IP20) → legenda pag. 178  
 Suitable for outdoor (lamp IP54) and indoor use  
 (lamp on charging base IP20) → legend pg. 178

**Avvertenze**

## Remarks

La stabilità della lampada è garantita con l'uso  
 di massimo tre prolunghe  
 The stability of the lamp is guaranteed when using  
 three extensions maximum

La testa della lampada può essere svitata per  
 avvicinarla a una fonte di alimentazione, facilitando  
 l'operazione di ricarica.  
 The head can be removed from the body of the lamp  
 for easier recharging.

**Accessori inclusi**

## Accessories included

Caricatore con entrata Micro-USB  
 Charger with a Micro-USB input

1 x Prolunga stelo  
 1 x Stem extension

**Non inclusi → pag. 169**

## Not included → pg. 169

Prolunga stelo aggiuntiva  
 Additional stem extension

**Finiture**

## Finishes

**LD0282B3**

Bianco  
 White  
 RAL 9002

**LD0282R3**

Corten

**LD0282N3**

Grigio scuro  
 Dark grey  
 RAL 7012

**Prolunga stelo**

## Stem extension

**LD0283B3**

Bianco  
 White  
 RAL 9002

**LD0283R3**

Corten

**LD0283N3**

Grigio scuro  
 Dark grey  
 RAL 7012

# Poldina

**Sospensione**  
Suspension lamp



Poldina suspension lamp white  
→ **LD0286B3**



Poldina sospensione è una lampada a batteria portatile e ricaricabile, dotata di touch dimmer.

Poldina suspension lamp is a battery-operated portable and rechargeable suspension lamp, equipped with dimmer touch control.

**Dati tecnici**

## Technical data

LED DIMMER • 2,2W • 188lm  
 3000K • IP54 • CRI>80  
 100-240V • 50-60Hz • 5Vdc max 1A

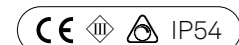

Pacco batteria al litio ricaricabile e sostituibile  
 Rechargeable and replaceable lithium battery pack

Durata di circa 9 h alla massima potenza  
 Battery lasts about 9 h at full power

Ricarica con cavo Micro-USB  
 Rechargeable with a Micro-USB cable

Tempo di ricarica a 1A: 6-8 h  
 Charging time at 1A: 6-8 h

Corpo in pressofusione di alluminio verniciato  
 Painted die-cast aluminium fixture

Diffusore in policarbonato  
 Polycarbonate diffuser

Adatta all'uso esterno (lampada IP54) e interno  
 (lampada su base di ricarica IP20) → legenda pag. 178  
 Suitable for outdoor (lamp IP54) and indoor use  
 (lamp on charging base IP20) → legend pg. 178

**Avvertenze**

## Remarks

La testa della lampada può essere svitata per avvicinarla a una fonte di alimentazione, facilitando l'operazione di ricarica.

The head can be removed from the body of the lamp for easier recharging.

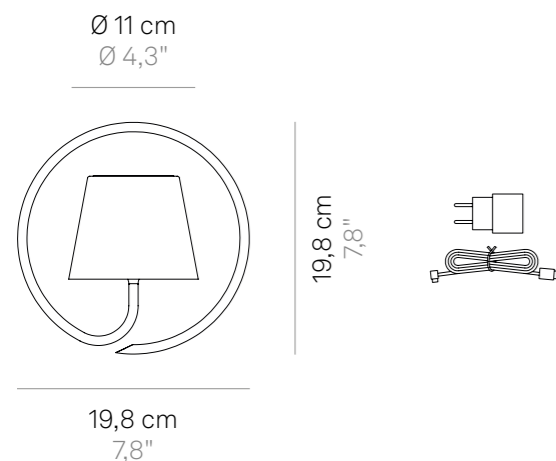
**Finiture**

## Finishes

**LD0286B3**

Bianco  
 White  
 RAL 9002

**LD0286R3**

Corten

**LD0286N3**

Grigio scuro  
 Dark grey  
 RAL 7012

**Accessori inclusi**

## Accessories included

Caricatore con entrata Micro-USB  
 Charger with a Micro-USB input



# Poldina

## Parete Wall lamp



Poldina parete è una lampada a batteria portatile e ricaricabile, disponibile in due versioni e dotata di touch dimmer.

Poldina wall lamp is a battery-operated portable and rechargeable lamp, available in two versions, and equipped with dimmer touch control.



Poldina wall lamp dark grey  
→ **LD0288N3**

**Dati tecnici**

Technical data

LED DIMMER • 2,2W • 188lm  
 3000K • IP54 • CRI>80  
 100-240V • 50-60Hz • 5Vdc max 1A



Pacco batteria al litio ricaricabile e sostituibile  
 Rechargeable and replaceable lithium battery pack

Durata di circa 9 h alla massima potenza  
 Battery lasts about 9 h at full power

Ricarica con cavo Micro-USB  
 Rechargeable with a Micro-USB cable

Tempo di ricarica a 1A: 6-8 h  
 Charging time at 1A: 6-8 h

Corpo in pressofusione di alluminio verniciato  
 Painted die-cast aluminium fixture

Diffusore in policarbonato  
 Polycarbonate diffuser

Adatta all'uso esterno (lampada IP54) e interno  
 (lampada su base di ricarica IP20) → legenda pag. 178  
 Suitable for outdoor (lamp IP54) and indoor use  
 (lamp on charging base IP20) → legend pg. 1780

**Avvertenze**

Remarks

La testa della lampada può essere svitata per avvicinarla a una fonte di alimentazione, facilitando l'operazione di ricarica.

The head can be removed from the body of the lamp for easier recharging.

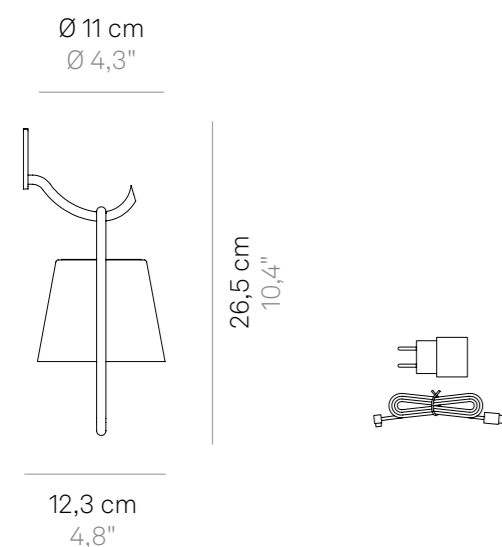
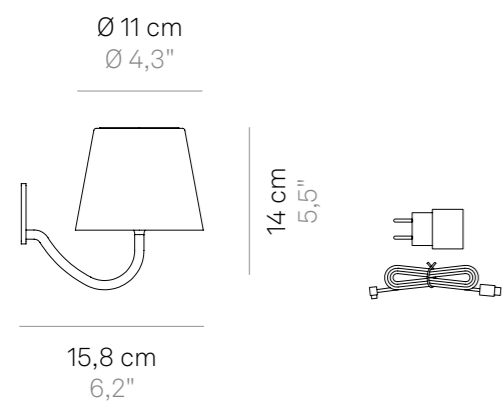

**Accessori inclusi**

Accessories included

Caricatore con entrata Micro-USB  
 Charger with a Micro-USB input

**Finiture**

Finishes



**LD0288B3**  
 Bianco  
 White  
 RAL 9002

**LD0288R3**  
 Corten

**LD0288N3**  
 Grigio scuro  
 Dark grey  
 RAL 7012



**LD0289B3**  
 Bianco  
 White  
 RAL 9002

**LD0289R3**  
 Corten

**LD0289N3**  
 Grigio scuro  
 Dark grey  
 RAL 7012

# Olivia

We are the custodians  
of a pure stone manor  
with its strong presence  
and hard, rugged rock.  
Illuminated, it is softened  
and when night falls  
we keep vigil motionless.

Siamo custodi  
di un maniero di pura pietra  
forte presenza  
roccia dura ed aspra.  
Illuminata si addolcisce  
scesa la notte  
vegliamo immobili.

TAVOLO / MINI TAVOLO  
TABLE LAMP / MINI TABLE LAMP



Olivia table lamp white  
→ **LD0850B3**  
Caglieron Caves  
Treviso, Italy



Current page: Olivia table lamp  
corten → **LD0850R3**  
Masseria Trulli e Vigne  
Martina Franca, Italy  
Photo Donato Fragnelli

Next page: Olivia table lamp  
corten → **LD0850R3**  
Glamping Canonici di  
San Marco - Mirano, Italy  
Photo Chiara Rigato



# Olivia

## Tavolo pro

Table lamp pro



Olivia è una lampada a batteria portatile e ricaricabile da tavolo. È dotata di base di ricarica a contatto, touch dimmer e funzione di memoria dell'impostazione di dimmerazione che memorizza gli step di dimmerazione; di conseguenza, ad ogni accensione, l'intensità luminosa corrisponderà a quella precedentemente impostata. La lampada è dotata inoltre della funzione di selezione della temperatura di colore della luce tra 2700K e 3000K (bianco dinamico).

Olivia is a battery-operated portable and rechargeable table lamp. It is equipped with contact charging base, dimmer touch control and dimmer memory function which adjusts the light intensity and memorises the dimmer steps; consequently, every time it is switched on, the light intensity will correspond to that previously set. The lamp is equipped also with a light colour temperature selection function, 2700K or 3000K (dynamic white).



Olivia table lamp corten → LD0850R3

**Dati tecnici**

## Technical data

LED DIMMER • 2,2W • 144-150lm  
 2700-3000K • IP65 • CRI>80  
 100-240V • 50-60Hz • 5Vdc max 1A



Pacco batteria al litio ricaricabile e sostituibile  
 Rechargeable and replaceable lithium battery pack

Durata di circa 9 h alla massima potenza  
 Battery lasts about 9 h at full power

Tempo di ricarica a 1A: 6-8 h  
 Charging time at 1A: 6-8 h

Corpo in pressofusione di alluminio verniciato  
 Painted die-cast aluminium fixture

Diffusore in policarbonato  
 Polycarbonate diffuser

Adatta all'uso esterno (lampada IP65) e interno  
 (lampada su base di ricarica IP20) → legenda pag. 178  
 Suitable for outdoor (lamp IP65) and indoor use  
 (lamp on charging base IP20) → legend pg. 178

Ø 11 cm  
 Ø 4,3"

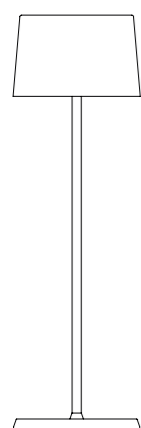

35 cm  
 13,7"

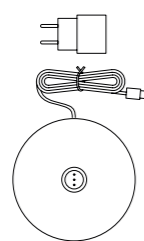

Ø 11 cm  
 Ø 4,3"

Ø 11,6 cm  
 Ø 4,5"

**Accessori inclusi**

## Accessories included

Base di ricarica a contatto  
 Contact charging base

**Avvertenze**

## Remarks

Le lampade con finitura foglia color oro, foglia color argento e foglia color rame non sono adatte per uso esterno.  
 The lamps with gold color leaf, silver color leaf and copper color leaf finish are not suitable for outdoor use.  
 Le lampade con finitura galvanica lucida oro e cromo non sono adatte per uso esterno.  
 The lamps with gold and chrome glossy galvanic finish are not suitable for outdoor use.

**Finiture**

## Finishes



**LD0850B3**  
 Bianco  
 White  
 RAL 9016



**LD0850R3**  
 Corten



**LD0850N3**  
 Grigio scuro  
 Dark grey  
 RAL 7027



**LD0850BFO**  
 Foglia color oro  
 Gold color leaf



**LD0850BFA**  
 Foglia color argento  
 Silver color leaf



**LD0850RFR**  
 Foglia color rame  
 Copper color leaf

Le lampade con finitura foglia color oro, foglia color argento e foglia color rame non sono adatte per uso esterno.  
 The lamps with gold color leaf, silver color leaf and copper color leaf finish are not suitable for outdoor use.

# Olivia mini NEW

## Tavolo pro Table lamp pro



Olivia mini è una lampada a batteria portatile e ricaricabile da tavolo. È dotata di base di ricarica a contatto, touch dimmer e funzione di memoria dell'impostazione di dimmerazione che memorizza gli step di dimmerazione; di conseguenza, ad ogni accensione, l'intensità luminosa corrisponderà a quella precedentemente impostata. La lampada è dotata inoltre della funzione di selezione della temperatura di colore della luce tra 2700K e 3000K (bianco dinamico).

Olivia mini is a battery-operated portable and rechargeable table lamp. It is equipped with contact charging base, dimmer touch control and dimmer memory function which adjusts the light intensity and memorizes the dimmer steps; consequently, every time it is switched on, the light intensity will correspond to that previously set. The lamp is equipped also with a light color temperature selection function, 2700K or 3000K (dynamic white).



Olivia mini table lamp corten  
→ **LD0860R3**

**Dati tecnici**

## Technical data

LED DIMMER • 2,2W • 144-150lm  
 2700-3000K • IP65 • CRI>80  
 100-240V • 50-60Hz • 5Vdc max 1A



Pacco batteria al litio ricaricabile e sostituibile  
 Rechargeable and replaceable lithium battery pack

Durata di circa 9 h alla massima potenza  
 Battery lasts about 9 h at full power

Tempo di ricarica a 1A: 6-8 h  
 Charging time at 1A: 6-8 h

Corpo in pressofusione di alluminio verniciato  
 Painted die-cast aluminium fixture

Diffusore in policarbonato  
 Polycarbonate diffuser

Adatta all'uso esterno (lampada IP65) e interno  
 (lampada su base di ricarica IP20) → legenda pag. 178  
 Suitable for outdoor (lamp IP65) and indoor use  
 (lamp on charging base IP20) → legend pg. 178

Ø 11 cm  
 Ø 4,3"

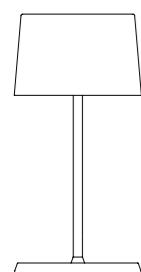

22 cm  
 8,7"

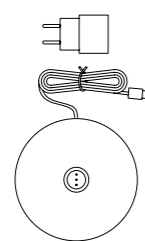

Ø 11 cm  
 Ø 4,3"

Ø 11,6 cm  
 Ø 4,5"

**Accessori inclusi**

Accessories included

Base di ricarica a contatto  
 Contact charging base

**Finiture**

## Finishes



**LD0860B3**  
 Bianco  
 White  
 RAL 9016



**LD0860R3**  
 Corten



**LD0860N3**  
 Grigio scuro  
 Dark grey  
 RAL 7027



**LD0860L3**  
 Lilla  
 Lilac  
 RAL 4005



**LD0860K3**  
 Blu Capri  
 Capri blue  
 RAL 5019



**LD0860V3**  
 Verde mela  
 Apple green  
 RAL 6018



**LD0860Z3**  
 Arancio  
 Orange  
 RAL 2008



# Ofelia

Edera, forte, intensa  
Giunte dopo un lungo errare  
Uniamo le nostre radici  
In un intimo cercarsi.

Ivy, strong and intense  
arriving after a long ramble  
we merge our roots  
in an intimate search.

TAVOLO  
TABLE LAMP



Ofelia table lamp white  
→ **LD0870B3**  
Storga river springs  
Treviso, Italy



Ofelia table lamp sage  
green → **LD0870G3**  
Ristorante Piastrino \*  
Pennabilli, Italy  
Photo Marco Poderi Studio

Current page:  
Ofelia table lamp  
sand → **LD0870S3**  
Ristorante Oltre  
Leporano, Italy  
Photo Giuseppe Musolino

Ofelia table lamp sage  
green → **LD0870G3**  
Alfio Ghezzi Bistrot  
Limone sul Garda, Italy  
Photo EALA



# Ofelia

## Tavolo pro

Table lamp pro



Ofelia table lamp sage green  
→ LD0870G3



Ofelia è una lampada a batteria portatile e ricaricabile da tavolo. È dotata di base di ricarica a contatto, touch dimmer e funzione di memoria dell'impostazione di dimmerazione che memorizza gli step di dimmerazione; di conseguenza, ad ogni accensione, l'intensità luminosa corrisponderà a quella precedentemente impostata. La lampada è dotata inoltre della funzione di selezione della temperatura di colore della luce tra 2700K e 3000K (bianco dinamico).

Ofelia is a battery-operated portable and rechargeable table lamp. It is equipped with contact charging base, dimmer touch control and dimmer memory function which adjusts the light intensity and memorises the dimmer steps; consequently, every time it is switched on, the light intensity will correspond to that previously set. The lamp is equipped also with a light colour temperature selection function, 2700K or 3000K (dynamic white).

**Dati tecnici**

## Technical data

LED DIMMER • 2,2W • 144-150lm  
 2700-3000K • IP65 • CRI>80  
 100-240V • 50-60Hz • 5Vdc max 1A

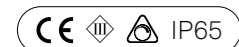

Pacco batteria al litio ricaricabile e sostituibile  
 Rechargeable and replaceable lithium battery pack

Durata di circa 9 h alla massima potenza  
 Battery lasts about 9 h at full power

Tempo di ricarica a 1A: 6-8 h  
 Charging time at 1A: 6-8 h

Corpo in pressofusione di alluminio verniciato  
 Painted die-cast aluminium fixture

Diffusore in policarbonato  
 Polycarbonate diffuser

Adatta all'uso esterno (lampada IP65) e interno  
 (lampada su base di ricarica IP20) → legenda pag. 178  
 Suitable for outdoor (lamp IP65) and indoor use  
 (lamp on charging base IP20) → legend pg. 178

10 x 10 cm  
 3,9 x 3,9"

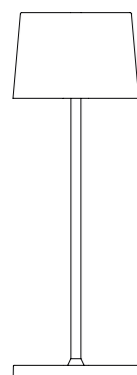

10 x 10 cm  
 3,9" x 3,9"

29 cm  
 11,4"

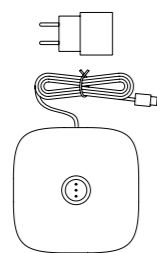

11,6 x 11,6 cm  
 4,5" x 4,5"

**Accessori inclusi**

Accessories included

Base di ricarica a contatto  
 Contact charging base

**Finiture**

## Finishes



**LD0870B3**  
 Bianco  
 White  
 RAL 9016



**LD0870R3**  
 Corten



**LD0870N3**  
 Grigio scuro  
 Dark grey  
 RAL 7024



**LD0870S3**  
 Sabbia  
 Sand  
 RAL 1014



**LD0870G3**  
 Salvia  
 Sage green  
 Pantone 5635U

# Pina

Piccola, docile  
mobile e leggera  
ti annidi e ti confondi.  
Gioca la luce  
offre dettagli dimenticati.

Small, gentle  
mobile and light  
you hide and blend in.  
Light brings playful effects  
offering forgotten details.

TAVOLO / SUPPORTO DA TERRA  
TABLE LAMP / FLOOR STAND



Pina table lamp white → **LD0650B3**  
Morgano countryside  
Treviso, Italy

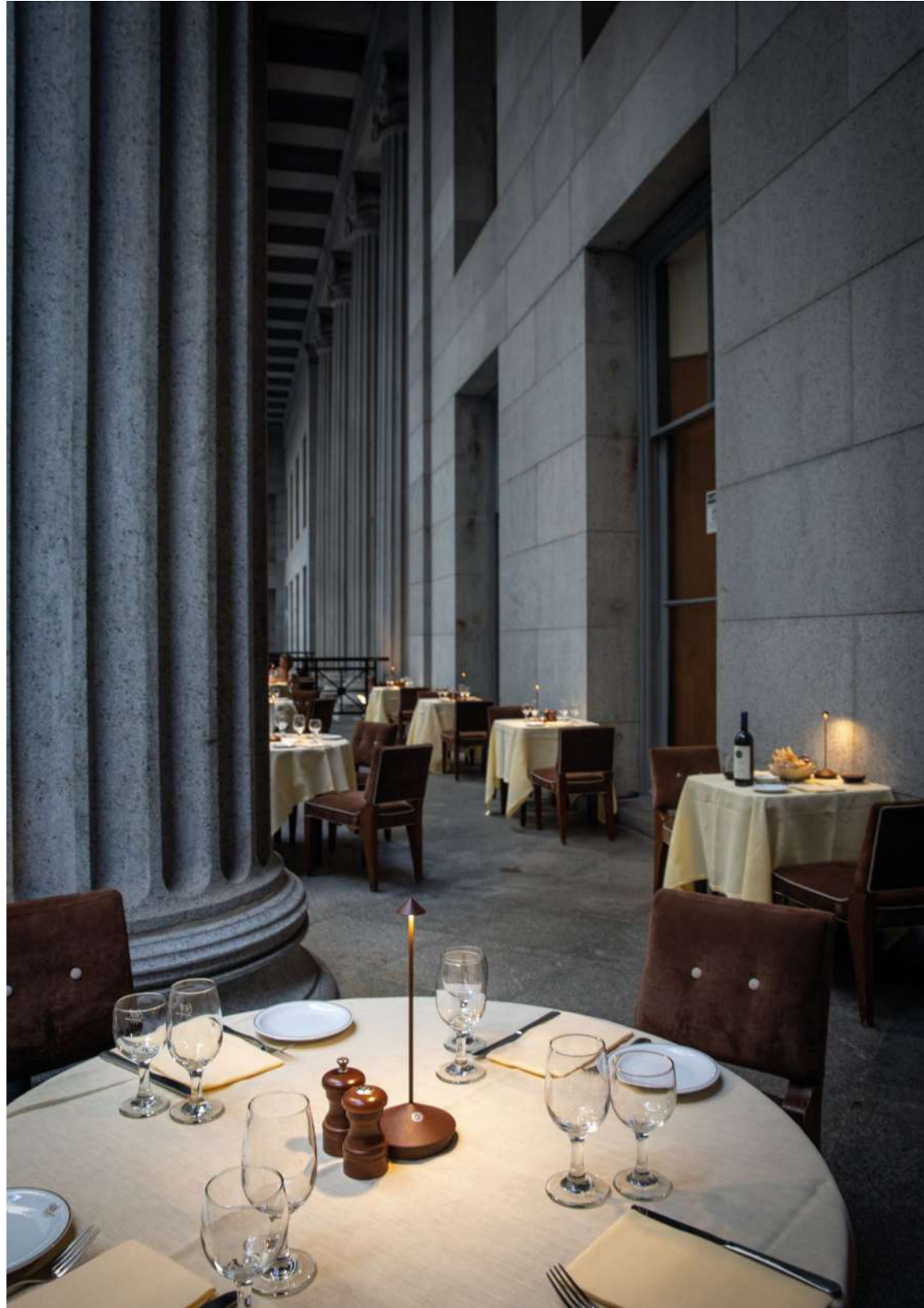

Previous page: Pina table lamp  
corten → **LD0650R3**  
Cipriani Club 55 - New York City,  
USA

Current page: Pina table lamp  
corten → **LD0650R3**  
Cipriani Club 55 - New York City,  
USA

Photo Kathi Littwin Photography



# Pina

## Tavolo pro Table lamp pro



Pina table lamp white  
→ **LD0650B3**



Pina è una lampada a batteria portatile e ricaricabile da tavolo. È dotata di base di ricarica a contatto e touch dimmer.

Pina is a battery-operated portable and rechargeable table lamp. It is equipped with contact charging base and dimmer touch control.

**Dati tecnici**

Technical data

LED DIMMER • 2,2W • 185lm  
 2700K • IP54 • CRI>80  
 100-240V • 50-60Hz • 5Vdc max 1A

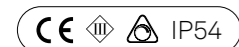

Pacco batteria al litio ricaricabile e sostituibile  
 Rechargeable and replaceable lithium battery pack

Durata di circa 12 h alla massima potenza  
 Battery lasts about 9 h at full power

Tempo di ricarica a 1A: 6-8 h  
 Charging time at 1A: 6-8 h

Corpo in pressofusione di alluminio verniciato  
 Painted die-cast aluminium fixture

Diffusore in policarbonato  
 Polycarbonate diffuser

Adatta all'uso esterno (lampada IP54) e interno  
 (lampada su base di ricarica IP20) → legenda pag. 178  
 Suitable for outdoor (lamp IP54) and indoor use  
 (lamp on charging base IP20) → legend pg. 178

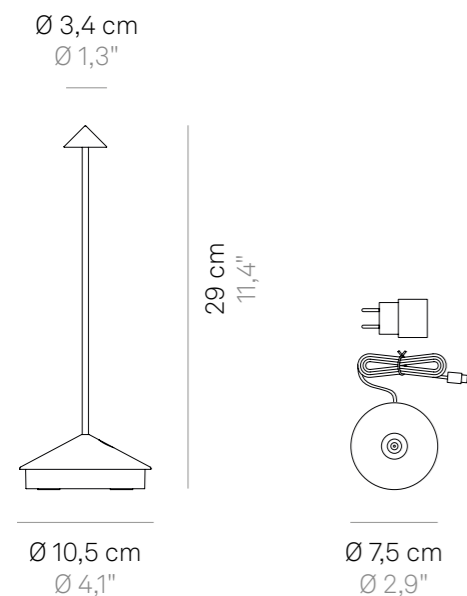

**Accessori inclusi**

Accessories included

Base di ricarica a contatto  
 Contact charging base

**Finiture**

Finishes



**LD0650B3**  
 Bianco  
 White  
 RAL 9003

**LD0650R3**  
 Corten

**LD0650N3**  
 Grigio scuro  
 Dark grey  
 RAL 7012

**LD0650S3**  
 Sabbia  
 Sand  
 RAL 1019



**LD0650D3**  
 Nero opaco  
 Matt black  
 RAL 9005



# Pina NEW

## Supporto da terra Floor stand



Supporto che trasforma la lampada da tavolo Pina (pag. 76) in una lampada con picchetto o lampada da terra. L'estremità inferiore del supporto si può montare secondo tre diverse configurazioni: solo con base; solo con picchetto; con picchetto e base, per aumentare la stabilità del supporto. La lampada Pina si alloggia esattamente nella parte superiore del supporto, senza agganciarsi, e può essere agilmente rimossa. Questo supporto da terra non assolve la funzione di ricarica.

A floor stand that turns Pina (page 76) into a floor lamp or a lamp with peg. The lower end of the stand can be mounted in three different configurations: with the base only; with the peg only; with both peg and base, to increase the stability of the stand. Pina lamp fits exactly in the upper part of the stand, without hooking for easy removal. This floor stand does not provide a charging function.



Pina table lamp black + Floor stand black  
→ LD0650D3 + LD0651D3





**Dati tecnici**

Technical data

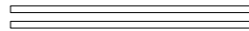

Corpo in alluminio verniciato  
Painted aluminium fixture

**Componenti inclusi**  
Components included

- 1 x Base d'appoggio per lampada  
1 x Housing for lamp 
- 1 x Base 
- 1 x Picchetto  
1 x Peg 
- 2 x Stelo  
2 x Stem 
- Kit di assemblaggio  
Assembling kit 

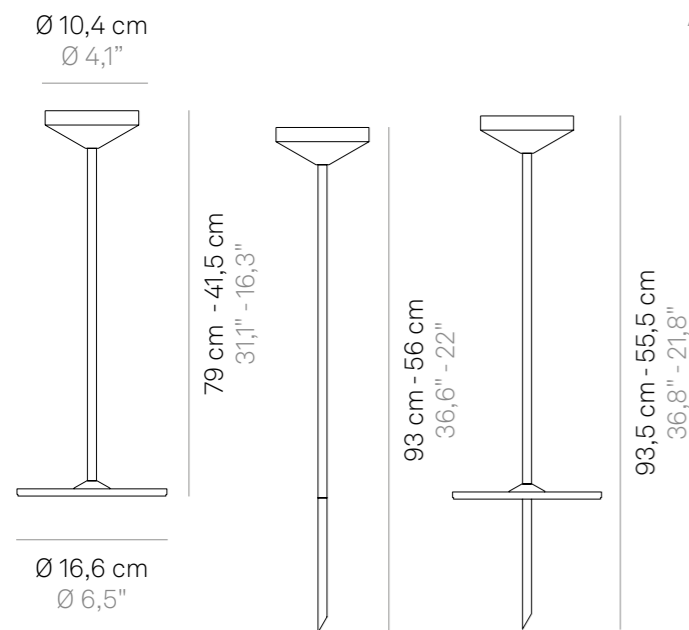

**Finiture**

Finishes

- |  |   |   |   |   |
|--|---|---|---|---|
|  |  |  |  |  |
| <b>LD0651B3</b><br>Bianco<br>White<br>RAL 9003                                     | <b>LD0651R3</b><br>Corten   | <b>LD0651N3</b><br>Grigio scuro<br>Dark grey<br>RAL 7012                            | <b>LD0651S3</b><br>Sabbia<br>Sand<br>RAL 1019                                       | <b>LD0651D3</b><br>Nero<br>Black<br>RAL 9005  |

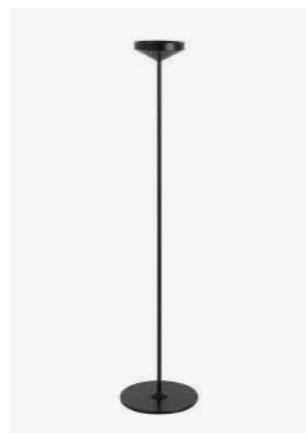

Pina table lamp white + Floor stand white  
→ **LD0650B3 + LD0651B3**

# Swap

Design Studio Kairos and Federico de Majo

Libellula ti muovi  
 Quasi invisibile  
 Diventi lucciola  
 Ci accudisci con una piccola luce  
 Vibrante di vetri e di raffinati veli  
 Trasformi per noi la tua essenza  
 E resti unica dolce compagna.

Dragonfly you move  
 Almost invisible  
 And become a firefly  
 Watching over us with a small light  
 Shimmering with glass and refined veils  
 You transform your essence for us  
 And remain the only sweet companion.

TAVOLO / ACCESSORI / MINI TAVOLO  
 TABLE LAMP/ ACCESSORIES / MINI TABLE LAMP



Swap table lamp white → **LD1010B3**  
 Swap mini table lamp white → **LD1011B3**  
 Cansiglio forest  
 Treviso, Italy

# Swap

## Tavolo pro Table lamp pro



Swap è una lampada a batteria portatile e ricaricabile da tavolo. È dotata di base di ricarica a contatto e touch dimmer. Il modello LD1020 va personalizzato con una gamma di paralumi in vetro o con un “fazzoletto” in tessuto, che si fissano alla testa della lampada tramite un magnete.

Swap is a battery-operated portable and rechargeable table lamp. It is equipped with contact charging base and dimmer touch control. The model LD1020 must be customized choosing from a range of glass lampshades or a fabric “handkerchief”, which are attached to the top of the lamp with a magnet.

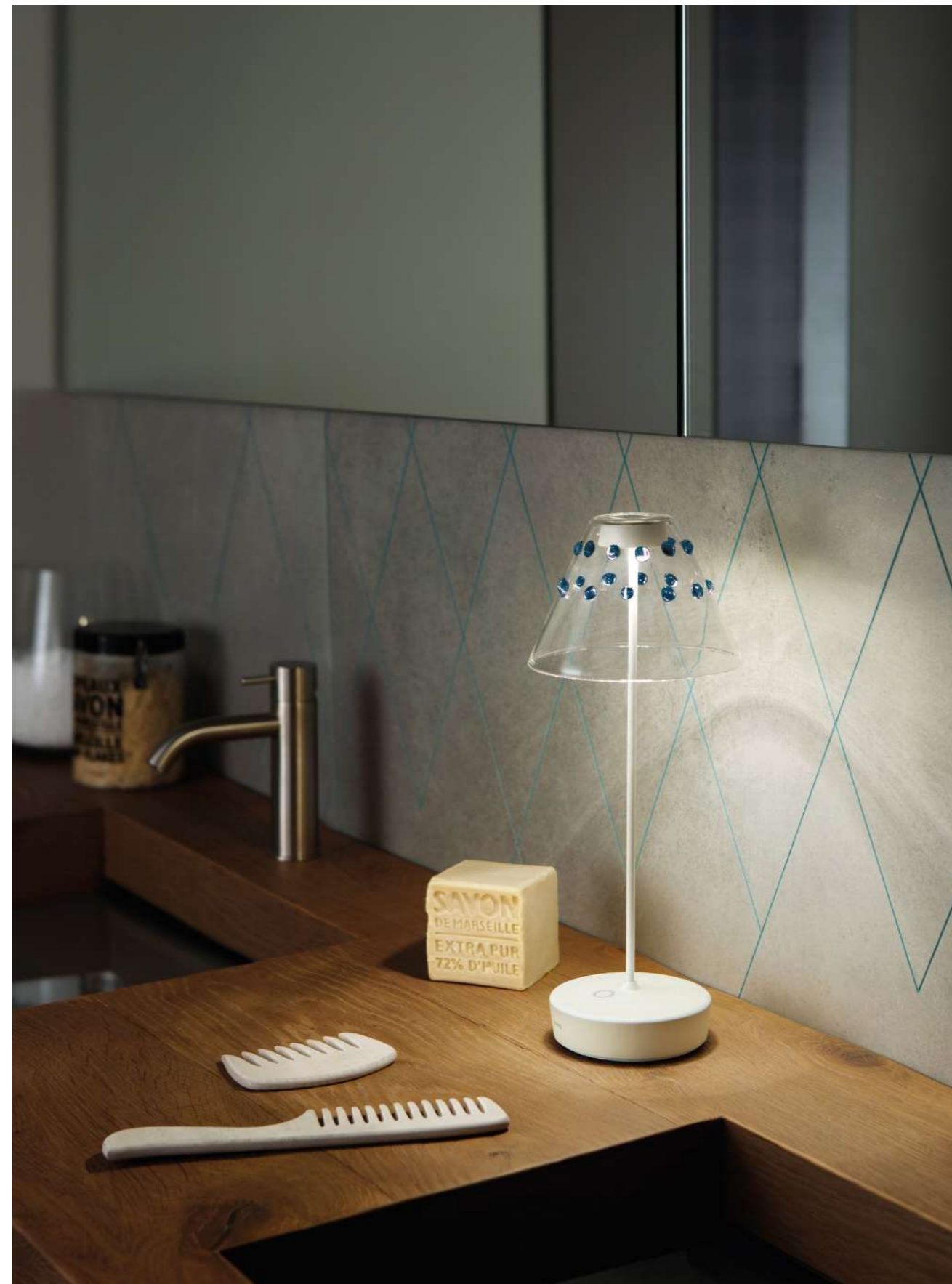

Swap table lamp white + glass lampshade  
→ LD1020B3 + LD102004

**Dati tecnici**

## Technical data

LED DIMMER • 2,2W • 183lm  
 2700K • IP65 • CRI>90  
 100-240V • 50-60Hz • 5Vdc max 1A



Ø 4,9 cm  
 Ø 1,9"

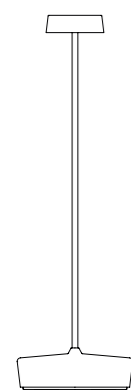

32,5 cm  
 12,8"

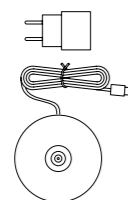

Ø 7,5 cm  
 Ø 2,9"

Ø 10 cm  
 Ø 3,9"

Ø 4,9 cm  
 Ø 1,9"

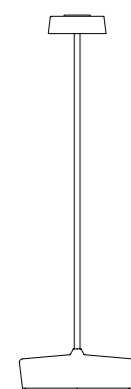

32,5 cm  
 12,8"

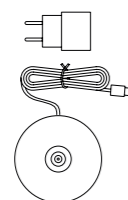

Ø 7,5 cm  
 Ø 2,9"

Ø 10 cm  
 Ø 3,9"

Pacco batteria al litio ricaricabile e sostituibile  
 Rechargeable and replaceable lithium battery pack

Durata di circa 12 h alla massima potenza  
 Battery lasts about 12 h at full power

Tempo di ricarica a 1A: 6-8 h  
 Charging time at 1A: 6-8 h

Corpo in pressofusione di alluminio verniciato  
 Painted die-cast aluminium fixture

Diffusore in policarbonato  
 Polycarbonate diffuser

Adatta all'uso esterno (lampada IP65) e interno  
 (lampada su base di ricarica IP20) → legenda pag. 178  
 Suitable for outdoor (lamp IP65) and indoor use  
 (lamp on charging base IP20) → legend pg. 178

#### Avvertenze

Remarks

Il modello LD1020 va personalizzato con una gamma di paralumi in vetro o con un "fazzoletto" in tessuto, che si fissano alla testa della lampada tramite un magnete  
 The model LD1020 must be customized choosing from a range of glass lampshades or a fabric "handkerchief", which are attached to the top of the lamp with a magnet

Da personalizzare con (pag. 90-92):  
 To be customized with (pg. 90-92):

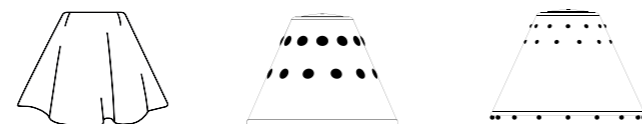
**Accessori inclusi**

Accessories included

Base di ricarica a contatto  
 Contact charging base

**Finiture**

## Finishes



**LD1010B3**  
 Bianco  
 White  
 RAL 9002



**LD1010R3**  
 Corten



**LD1010N3**  
 Nero  
 Black  
 RAL 9005



**LD1020B3 \***  
 Bianco  
 White  
 RAL 9002



**LD1020R3 \***  
 Corten



**LD1020N3 \***  
 Nero  
 Black  
 RAL 9005

\* Completa la tua lampada (pag. 90-92)  
 Complete your lamp (pg. 90-92)

# Marylin

## Paralume in tessuto Fabric lampshade



Paralume morbido in tessuto elastico ignifugo, lavabile e ingualcibile, con orlo sopraffilato. È dotato di un dischetto in policarbonato che permette al tessuto di agganciarsi stabilmente alla lampada.

A soft lampshade made of fire-retardant elastic fabric, which is washable and crease-resistant, with zig-zag edging. It has a polycarbonate disc that allows the fabric to be firmly attached to the lamp.

### Dati tecnici Technical data



Ø 33 cm  
Ø 13"

Paralume morbido in tessuto elastico ignifugo, lavabile e ingualcibile  
Lampshade in fireproof, washable, wrinkle-resistant, elastic fabric  
Dischetto in policarbonato  
Polycarbonate disk

### Accessori inclusi Accessories included

Magnete  
Magnet

### Finiture Finishes



**LD102000**  
Bianco  
White



### Accessorio per Accessory for



**LD1020B3**  
Bianco  
White  
RAL 9002



**LD1020R3**  
Corten



**LD1020N3**  
Nero  
Black  
RAL 9005



# Dots

## Paralume in vetro Glass lampshade



Paralume in vetro borosilicato soffiato e lavorato a mano, trasparente con decorazioni a rilievo nei colori bianco, nero, ambra o blu.

A handcrafted, blown borosilicate glass lampshade, in clear glass with relief decorations in white, black, amber or blue.

### Dati tecnici Technical data

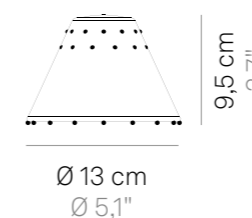

Paralume in vetro borosilicato soffiato e lavorato a mano  
Lampshade in blown and handmade borosilicate glass

### Accessori inclusi Accessories included

Magnete  
Magnet

### Finiture Finishes



**LD102001**  
Bianco  
White



**LD102002**  
Nero  
Black



**LD102003**  
Ambra  
Amber



**LD102004**  
Blu  
Blue



Decoro 25 punti

### Finiture Finishes



**LD102011**  
Bianco  
White



**LD102012**  
Nero  
Black



**LD102013**  
Ambra  
Amber



**LD102014**  
Blu  
Blue



Decoro 41 punti

### Accessorio per Accessory for



**LD1020B3**  
Bianco  
White  
RAL 9002



**LD1020R3**  
Corten



**LD1020N3**  
Nero  
Black  
RAL 9005



# Swap mini NEW

**Tavolo pro**  
Table lamp pro



Swap mini è una lampada a batteria portatile e ricaricabile da tavolo. È dotata di base di ricarica a contatto e touch dimmer.

Swap mini is a battery-operated, portable and rechargeable table lamp. It has a contact charging base and dimmer touch control.



Swap mini table lamp white  
→ LD1011B3



**Dati tecnici**

## Technical data

LED DIMMER • 2,2W • 183lm  
 2700K • IP65 • CRI>90  
 100-240V • 50-60Hz • 5Vdc max 1A



Pacco batteria al litio ricaricabile e sostituibile  
 Rechargeable and replaceable lithium battery pack

Durata di circa 13 h alla massima potenza  
 Battery lasts about 13 h at full power

Tempo di ricarica a 1A: 6-8 h  
 Charging time at 1A: 6-8 h

Corpo in pressofusione di alluminio verniciato  
 Painted die-cast aluminium fixture

Diffusore in policarbonato  
 Polycarbonate diffuser

Adatta all'uso esterno (lampada IP65) e interno  
 (lampada su base di ricarica IP20) → legenda pag. 178  
 Suitable for outdoor (lamp IP65) and indoor use  
 (lamp on charging base IP20) → legend pag. 178

**Avvertenze**

## Remarks

Le lampade con finitura galvanica lucida oro e cromo  
 non sono adatte per uso esterno.  
 The lamps with gold and chrome glossy galvanic finish  
 are not suitable for outdoor use.

Ø 4,9 cm  
 Ø 1,9"

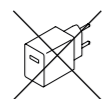

non incluso  
 not included

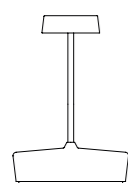

14,8 cm  
 5,8"

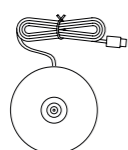

Ø 10 cm  
 Ø 3,9"

Ø 7,5 cm  
 Ø 2,9"

**Accessori inclusi**

Accessories included

Base di ricarica a contatto  
 Contact charging base

**Accessori non inclusi**

Accessories not included

Caricatore  
 Charger

**Finiture**

## Finishes

**LD1011B3**

Bianco  
 White  
 RAL 9002

**LD1011R3**

Corten

**LD1011N3**

Nero  
 Black  
 RAL 9005

**LD1011L3**

Lilla  
 Lilac  
 RAL 4005

**LD1011K3**

Blu Capri  
 Capri blue  
 RAL 5019

**LD1011V3**

Verde mela  
 Apple green  
 RAL 6018

**LD1011Z3**

Arancio  
 Orange  
 RAL 2008

**LD1011O3**

Oro lucido  
 Glossy gold  
 Galvanic finish

**LD1011C3**

Cromo lucido  
 Glossy chromo  
 Galvanic finish

Le lampade con finitura galvanica lucida oro e cromo non sono adatte per uso esterno.  
 The lamps with gold and chrome glossy galvanic finish are not suitable for outdoor use.

# Home

Voglio una casa illuminata  
 Tanto grande e tanto piccola  
 Come la penso ogni giorno  
 Con tanti o pochi amici  
 Vere presenze  
 Penso la casa sul mare e sulla sabbia  
 Sul prato ombreggiato dal tiglio  
 E sulla montagna dopo il tramonto  
 Che racconta dei nostri tanti passi.

I'd like a bright house  
 As large and as small  
 As I imagine it every day  
 With many or a few friends  
 True presences  
 I imagine a house by the sea and on the sand  
 On the lawn, in the shade of a linden tree  
 And in the mountains after sunset  
 That reveals our many steps.

TAVOLO  
 TABLE LAMP



Home table lamp white → **LD0258B3**  
 Home table lamp dark grey → **LD0258N3**

Euganean hills  
 Padua, Italy

# Home

## Tavolo pro Table lamp pro



Home table lamp white  
→ **LD0258B3**

Home è una lampada a batteria portatile e ricaricabile da tavolo. È dotata di base di ricarica a contatto e touch dimmer.

Home is a battery-operated portable and rechargeable table lamp. It is equipped with contact charging base and dimmer touch control.



**Dati tecnici**

## Technical data

LED DIMMER • 2,2W • 165lm  
 3000K • IP54 • CRI>80  
 100-240V • 50-60Hz • 5Vdc max 1A

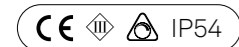

Pacco batteria al litio ricaricabile e sostituibile  
 Rechargeable and replaceable lithium battery pack

Durata di circa 12 h alla massima potenza  
 Battery lasts about 12 h at full power

Tempo di ricarica a 1A: 6-8 h  
 Charging time at 1A: 6-8 h

Corpo in pressofusione di alluminio verniciato  
 Painted die-cast aluminium fixture

Diffusore in policarbonato  
 Polycarbonate diffuser

Adatta all'uso esterno (lampada IP54) e interno  
 (lampada su base di ricarica IP20) → legenda pag. 178  
 Suitable for outdoor (lamp IP54) and indoor use  
 (lamp on charging base IP20) → legend pg. 178

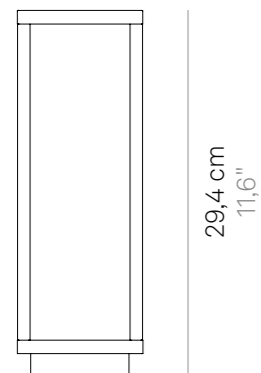

29,4 cm  
 11,6"

10 x 10 cm  
 3,9" x 3,9"

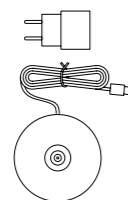

Ø 7,5 cm  
 Ø 2,9"

**Accessori inclusi**

Accessories included

Base di ricarica a contatto  
 Contact charging base

**Finiture**

## Finishes



**LD0258B3**  
 Bianco  
 White  
 RAL 9016



**LD0258R3**  
 Corten



**LD0258N3**  
 Grigio scuro  
 Dark grey  
 RAL 7012

# Dama

A stone shines  
light awakens it  
while a small moon  
radiates a faint yet vibrant glow.  
The endless passage of much water  
has patiently smoothed it.

Un sasso risplende  
la luce lo risveglia  
mentre una piccola luna  
emana un chiarore flebile ma vivo.  
È il passaggio perpetuo di tanta acqua  
che paziente lo ha levigato.

TAVOLO USB  
TABLE LAMP USB

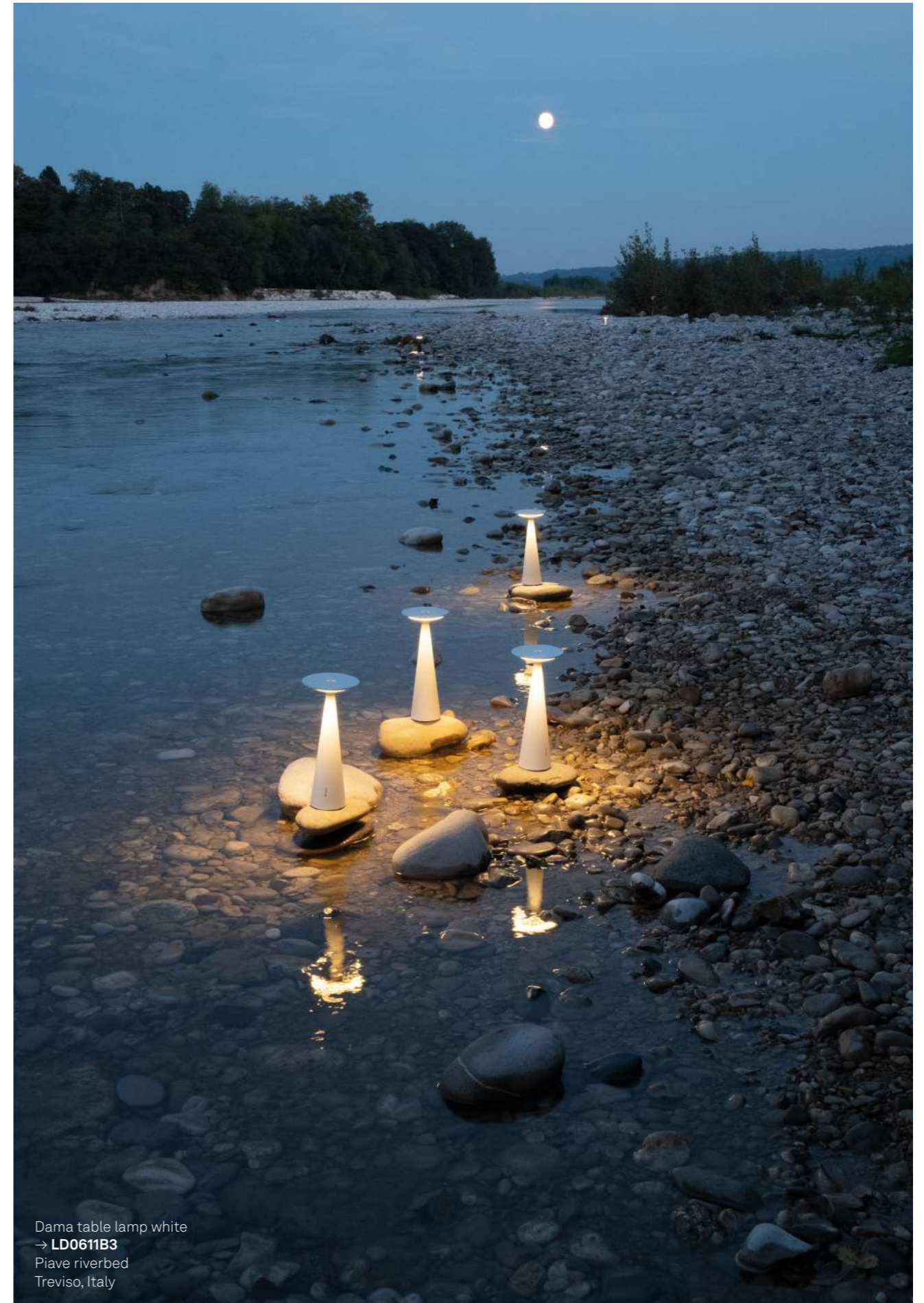

Dama table lamp white  
→ **LD0611B3**  
Piave riverbed  
Treviso, Italy



Previous page: Dama table  
lamp white → **LD0611B3**  
Ristorante Le Lampare al  
Fortino - Trani, Italy  
Photo Vito Rizzi Photographer

Current page: Dama table lamp  
black → **LD0611N3**  
Ristorante Noir - Ponzano, Italy  
Photo phEsci Francesco Esci



# Dama

## Tavolo pro USB Table lamp pro USB



Dama table lamp white  
→ **LD0611B3**

Dama è una lampada a batteria portatile e ricaricabile da tavolo. È dotata di base di ricarica a contatto, touch dimmer e funzione di selezione della temperatura di colore della luce tra 2700K e 3000K (bianco dinamico). La lampada dispone di una porta USB-a, che consente la ricarica di dispositivi mobili.

Dama is a battery-operated portable and rechargeable table lamp. It is equipped with contact charging base, dimmer touch control and a light colour temperature selection function, 2700K or 3000K (dynamic white). Available with a USB-a port for charging mobile devices.

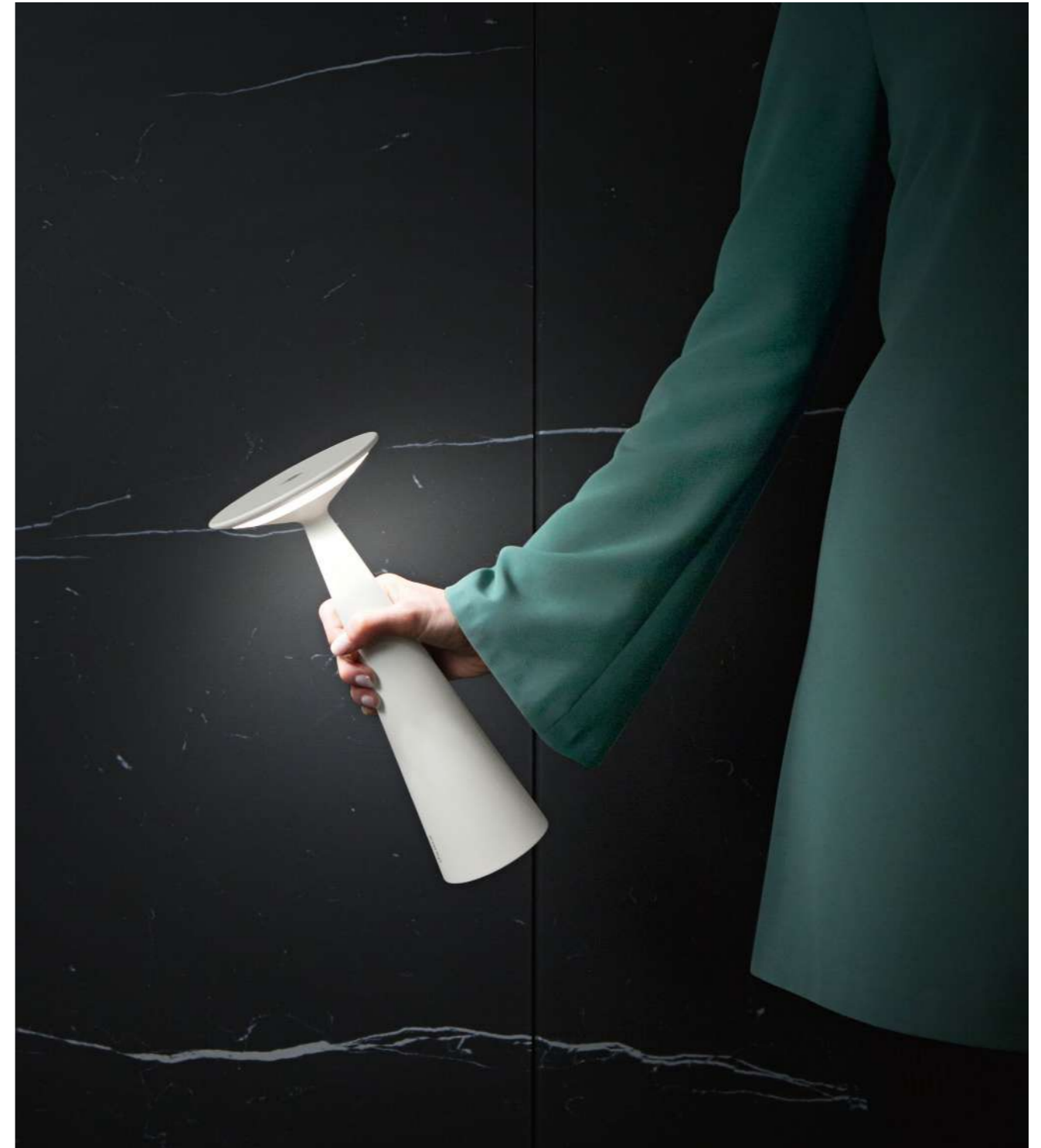

**Dati tecnici**

## Technical data

LED DIMMER • 2,2W • 166-178lm  
 2700-3000K • IP54 • CRI>80  
 100-240V • 50-60Hz • 5Vdc max 1A

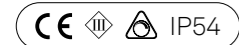

Pacco batteria al litio ricaricabile e sostituibile  
 Rechargeable and replaceable lithium battery pack

Durata di circa 9 h alla massima potenza  
 Battery lasts about 9 h at full power

Tempo di ricarica a 1A: 6-8 h  
 Charging time at 1A: 6-8 h

Corpo in pressofusione di alluminio verniciato  
 Painted die-cast aluminium fixture

Diffusore in policarbonato  
 Polycarbonate diffuser

Adatta all'uso esterno (lampada IP54) e interno  
 (lampada su base di ricarica IP20) → legenda pag. 178  
 Suitable for outdoor (lamp IP54) and indoor use  
 (lamp on charging base IP20) → legend pg. 178

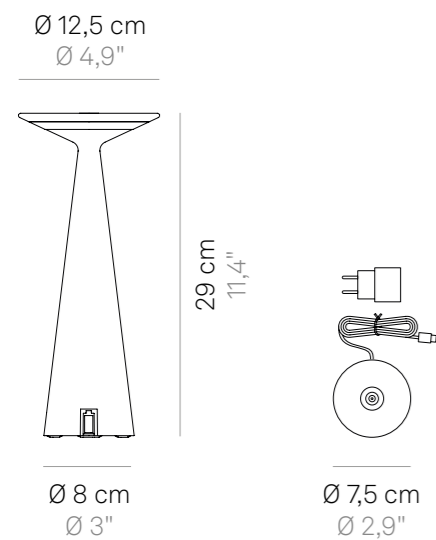
**Finiture**

## Finishes

**LD0611B3**

Bianco  
 White  
 RAL 9003

**LD0611N3**

Nero  
 Black  
 RAL 9005

**Accessori inclusi**

Accessories included

Base di ricarica a contatto  
 Contact charging base



# Olimpia

Design Federico de Majo

Luna luminosa, piena  
la tua luce  
penetra nei solchi, negli anfratti.  
Gradino dopo gradino  
ci avviciniamo.

Bright full moon  
your light  
penetrates furrows and crevices.  
Step by step  
we draw near.

TAVOLO  
TABLE LAMP

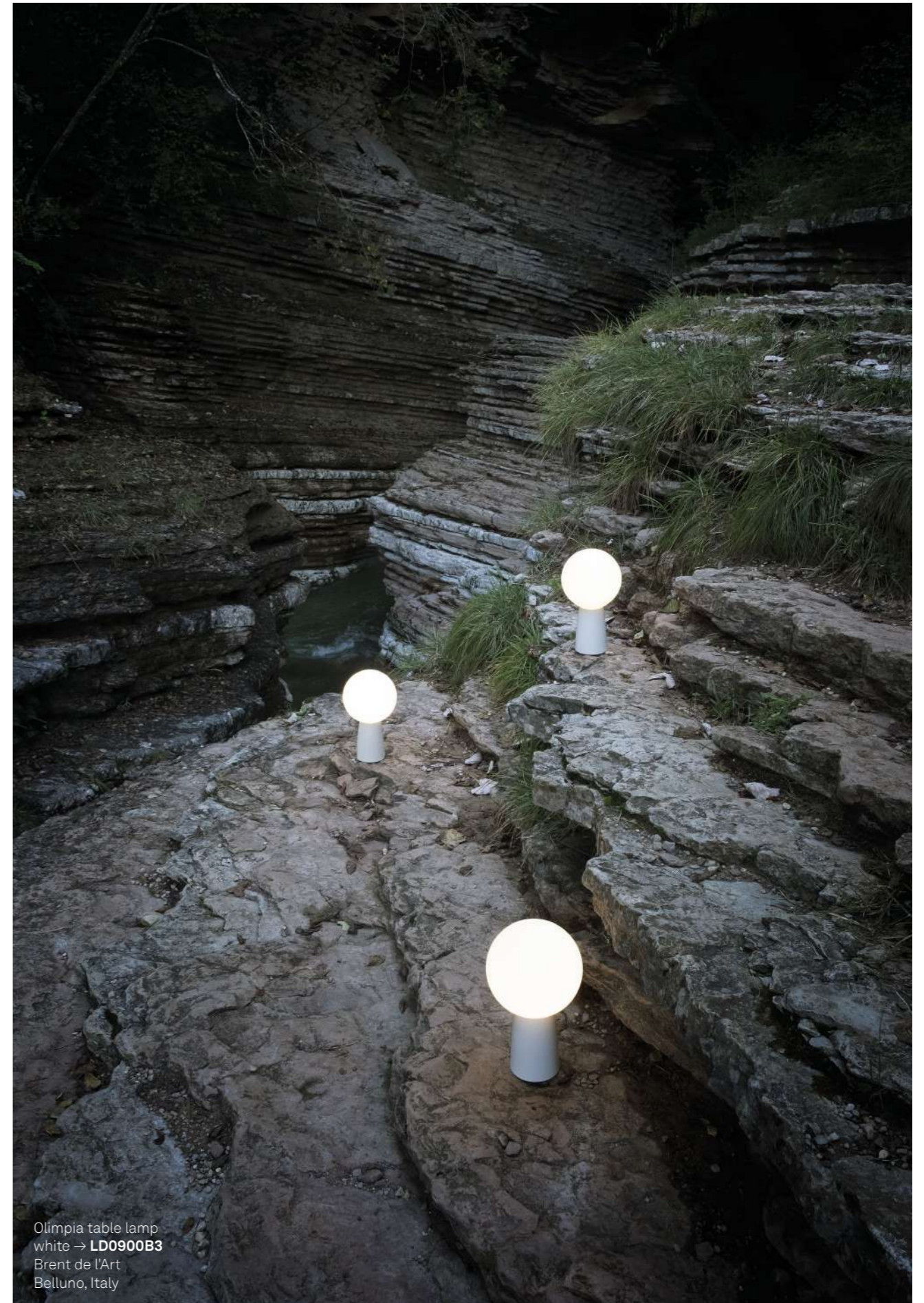

Olimpia table lamp  
white → **LD0900B3**  
Brent de l'Art  
Belluno, Italy



Olimpia table lamp white  
→ **LD0900B3**  
Enoteca Ombre Rosse  
Preganziol, Italy  
Photo phEsci Francesco Esci



# Olimpia

## Tavolo pro Table lamp pro



Olimpia è una lampada a batteria portatile e ricaricabile da tavolo. È dotata di base di ricarica a contatto, touch dimmer e di una lente (accessorio) per rendere la luce più calda (2700K).

Olimpia is a battery-operated portable and rechargeable table lamp. It is equipped with contact charging base, dimmer touch control and an accessory lens to warm the color temperature of light (2700K).

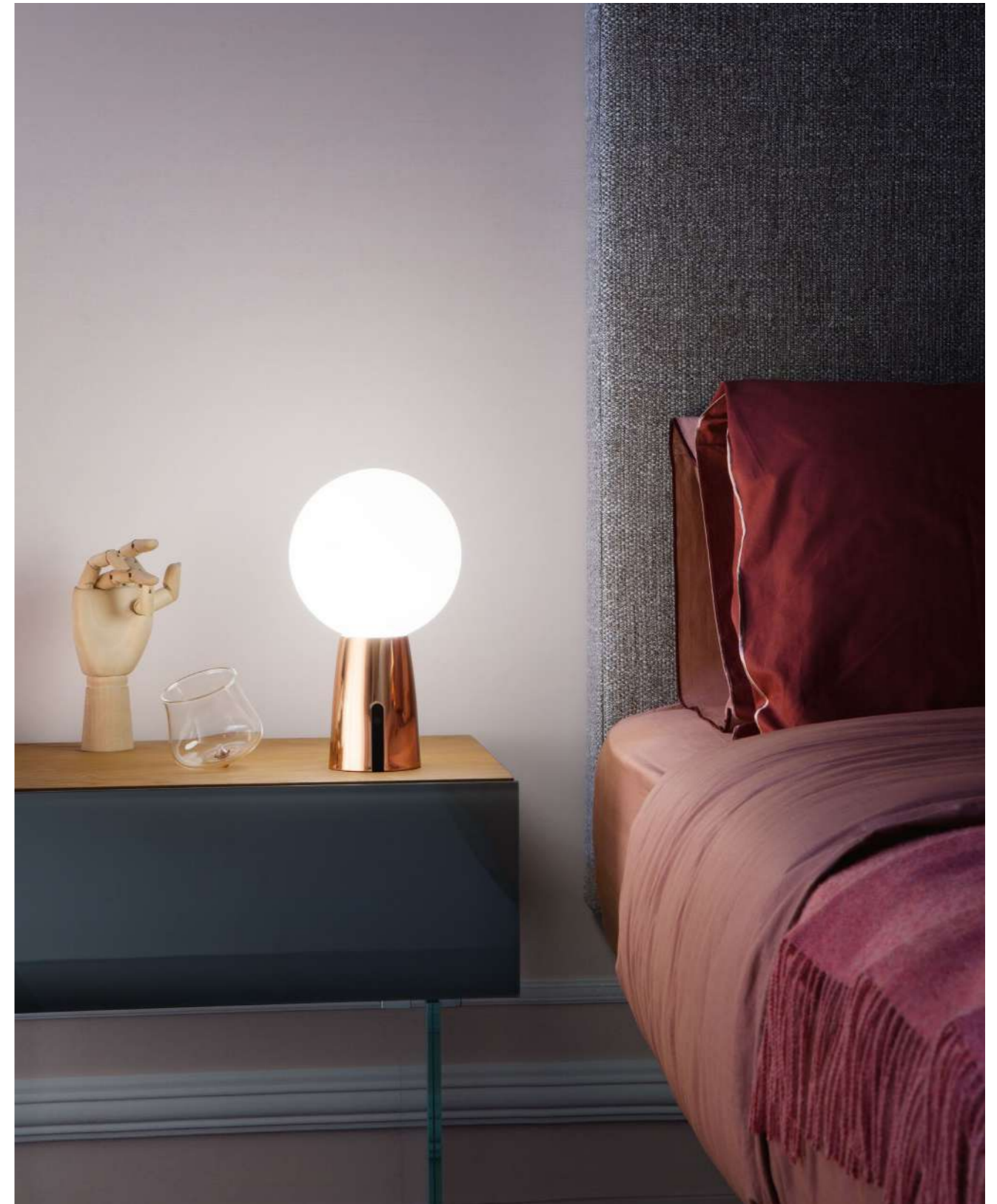

Olimpia table lamp copper  
→ **LD0900E3**

**Dati tecnici**

## Technical data

LED DIMMER • 2,5W • 200lm  
 3000K • IP54 • CRI>80  
 100-240V • 50-60Hz • 5Vdc max 1A



Pacco batteria al litio ricaricabile e sostituibile  
 Rechargeable and replaceable lithium battery pack

Durata di circa 9 h alla massima potenza  
 Battery lasts about 9 h at full power

Tempo di ricarica a 1A: circa 9 h  
 Charging time at 1A: about 9 h

Corpo in pressofusione di alluminio verniciato  
 Painted die-cast aluminium fixture

Diffusore in policarbonato  
 Polycarbonate diffuser

Adatta all'uso esterno (lampada IP54) e interno  
 (lampada su base di ricarica IP20) → legenda pag. 178  
 Suitable for outdoor (lamp IP54) and indoor use  
 (lamp on charging base IP20) → legend pg. 178

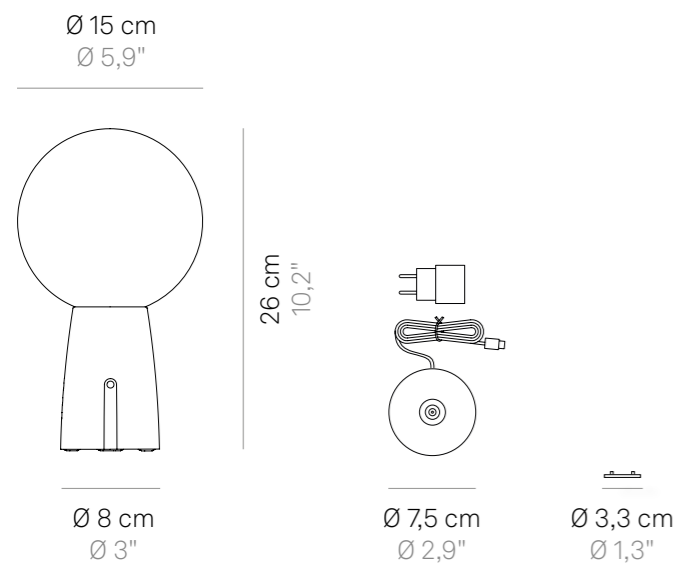
**Accessori inclusi**  
 Accessories included

Base di ricarica a contatto  
 Contact charging base

Lente  
 Lens

**Avvertenze**  
 Remarks

Le lampade con finitura oro, cromo e rame non sono adatte per uso esterno.  
 The lamps with gold, chrome and silver finish are not suitable for outdoor use.

**Finiture**

## Finishes



**LD0900B3**  
 Bianco  
 White  
 RAL 9003

**LD0900N3**  
 Grigio scuro  
 Dark grey  
 RAL 7012



**LD090003**  
 Oro  
 Gold

**LD0900C3**  
 Cromo  
 Chrome

**LD0900E3**  
 Rame  
 Copper

Le lampade con finitura color oro, cromo e rame non sono adatte per uso esterno.  
 The lamps with gold, chromo and copper finish are not suitable for outdoor use.

# Sister Light

Design Federico de Majo

An enchanted forest  
rich in greenery  
and glowing mushrooms.  
Eyes of elves, hidden  
spy on your many powers.

Un bosco incantato  
ricco di vegetazione  
e funghi fosforescenti.  
Occhi di elfi, nascosti  
spiano le tue molteplici abilità.

TAVOLO / MINI TAVOLO / MINI BOWL/PIATTO / PICCHETTO / PARETE  
TABLE LAMP / MINI TABLE LAMP / MINI TABLE BOWL/PLATE / LAMP WITH PEG / WALL LAMP

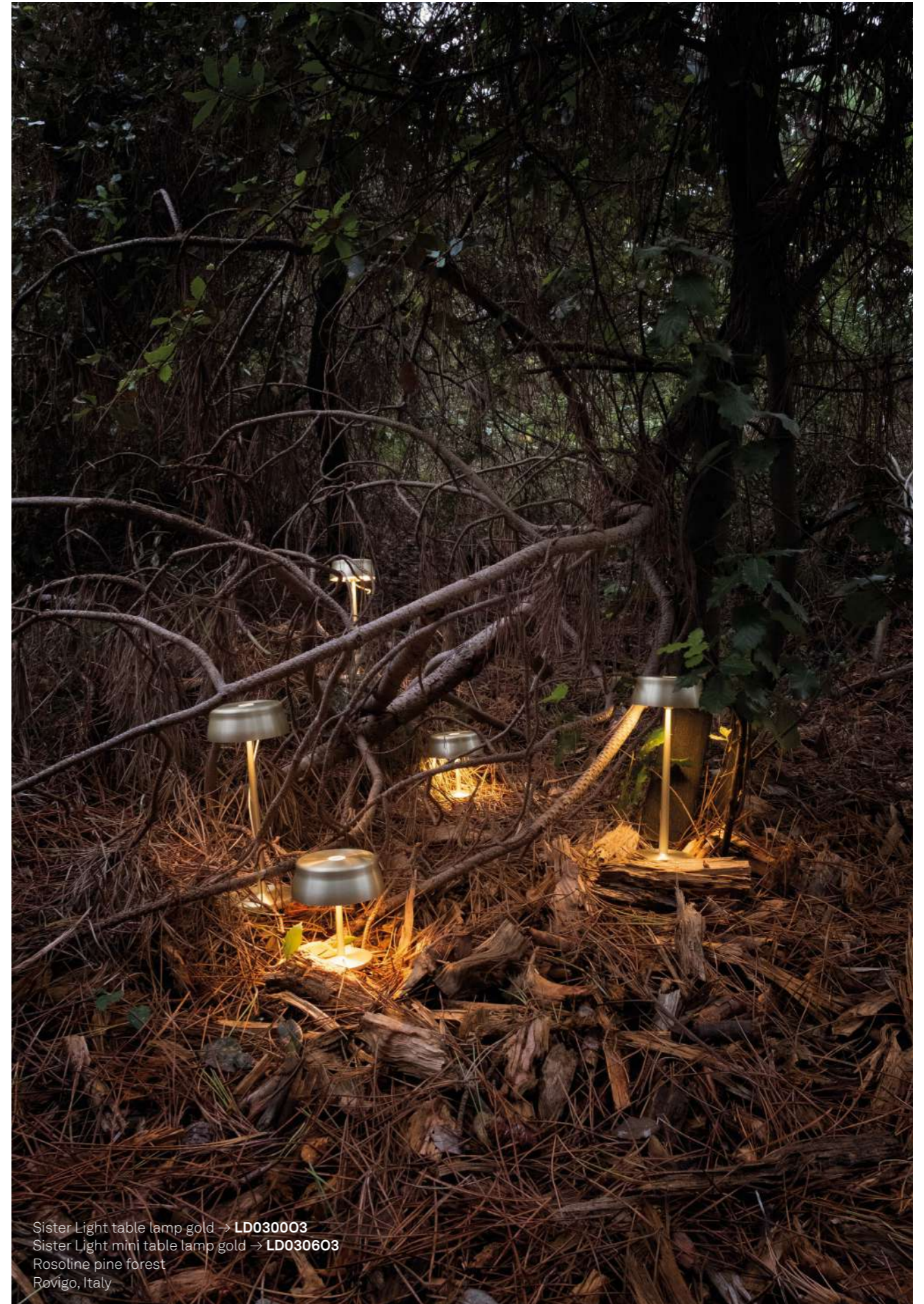

Sister Light table lamp gold → **LD030003**  
Sister Light mini table lamp gold → **LD030603**  
Rosoline pine forest  
Rovigo, Italy



Sister Light table  
lamp copper → **LD0300R3**  
42 Restaurant & Bar  
Esztergom, Hungary  
Photo Patrik Fábian

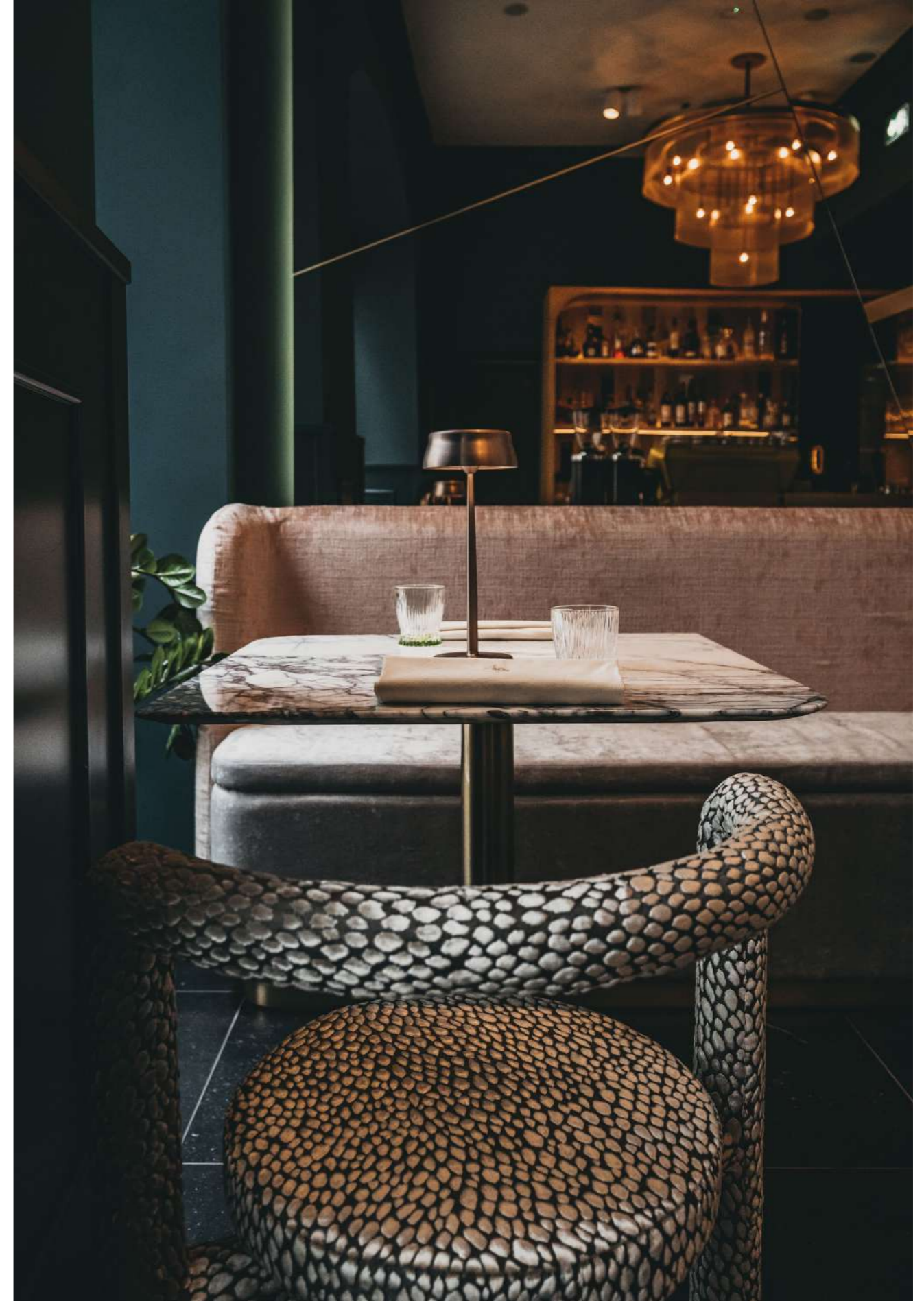

# Sister Light

**Tavolo**  
Table lamp



Sister Light è una lampada a batteria portatile e ricaricabile da tavolo. È dotata di un sistema di controllo elettronico che monitora l'autonomia residua e garantisce un flusso luminoso costante fino all'esaurimento della batteria. Un menu touch multifunzione permette di regolare la temperatura di colore della luce tra 2700-3350-4000K (bianco dinamico) e impostare o escludere la dimmerazione a 4 step. La testa della lampada, fissata sullo stelo è convertibile a fissaggio magnetico e dunque può essere separata per diventare una fonte luminosa di emergenza. La base della lampada è predisposta per il fissaggio meccanico al tavolo.

Sister Light is a battery-operated portable and rechargeable table lamp. It is equipped with an electronic control system monitors the remaining autonomy and ensures constant luminous flux until the battery runs out. A customisable multifunctional touch control menu allows you to adjust the light color temperature to 2700-3350-4000K (dynamic white) and to set or exclude the 4-step dimmer function. The top of the lamp, fixed to the stem, can be converted to magnetic fixing and detached to become an emergency light. The base of the lamp is designed to be mechanically fixed to a table.



Sister Light table lamp blue  
→ LD0300B3

**Dati tecnici**

## Technical data

LED DIMMER • 3W • 250-260-270lm  
2700-3150-4000K • IP65 • CRI>90  
100-240V • 50-60Hz • 5Vdc max 2A

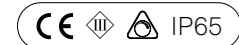

Pacco batteria al litio ricaricabile e sostituibile  
Rechargeable and replaceable lithium battery pack

Durata 8 - 58 h, in base alla regolazione del flusso luminoso  
Battery lasts 8 - 58 h, depending on the luminous flux setting.

Ricarica con cavetto USB-c  
Rechargeable with a USB-c cable

Tempo di ricarica a 2A: circa 5 h  
Charging time at 2A: about 5 h

Corpo in alluminio anodizzato  
Anodized aluminium fixture

Diffusore in policarbonato prismatico  
Prismatic polycarbonate diffuser

Adatta all'uso esterno (lampada IP65) e interno (lampada su base di ricarica IP20) → legenda pag. 178  
Suitable for outdoor (lamp IP65) and indoor use (lamp on charging base IP20) → legend pg. 178

Resistenza agli urti (IK07) e alla nebbia salina (1500h)  
Impact resistance (IK07) and salt spray resistance (1500h)

Ø 13,2 cm  
Ø 5,2"

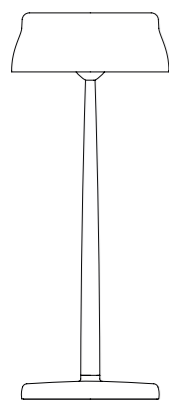

32,8 cm  
12,9"



non incluso  
not included



Ø 11 cm  
Ø 4,3"

**Accessori inclusi**

Accessories included

Cavo di ricarica con entrata USB-c  
Charging cable with USB-c input

Kit per fissaggio magnetico  
Kit for magnetic fixing

Kit per fissaggio meccanico al tavolo  
Kit for mechanical fixing to a table

**Accessori non inclusi**

Accessories not included

Caricatore  
Charger

**Finiture**

## Finishes



**LD0300A3**  
Alluminio  
Aluminium



**LD0300B3**  
Blu  
Blue



**LD0300O3**  
Oro  
Gold



**LD0300R3**  
Rame  
Copper



**LD0300V3**  
Verde  
Green



# Sister Light mini

## Tavolo

Table lamp



Sister Light mini è una lampada a batteria portatile e ricaricabile da tavolo. È dotata di un sistema di controllo elettronico che monitora l'autonomia residua e garantisce un flusso luminoso costante fino all'esaurimento della batteria. Un menu touch multifunzione permette di regolare la temperatura di colore della luce tra 2700-3350-4000K (bianco dinamico) e impostare o escludere la dimmerazione a 4 step. La testa della lampada, fissata sullo stelo è convertibile a fissaggio magnetico e dunque può essere separata per diventare una fonte luminosa di emergenza. La base della lampada è predisposta per il fissaggio meccanico al tavolo.

Sister Light mini is a battery-operated portable and rechargeable table lamp. It is equipped with an electronic control system monitors the remaining autonomy and ensures constant luminous flux until the battery runs out. A customisable multifunctional touch control menu allows you to adjust the light color temperature to 2700-3350-4000K (dynamic white) and to set or exclude the 4-step dimmer function. The top of the lamp, fixed to the stem, can be converted to magnetic fixing and detached to become an emergency light. The base of the lamp is designed to be mechanically fixed to a table.

Sister Light mini table lamp  
gold → LD030603

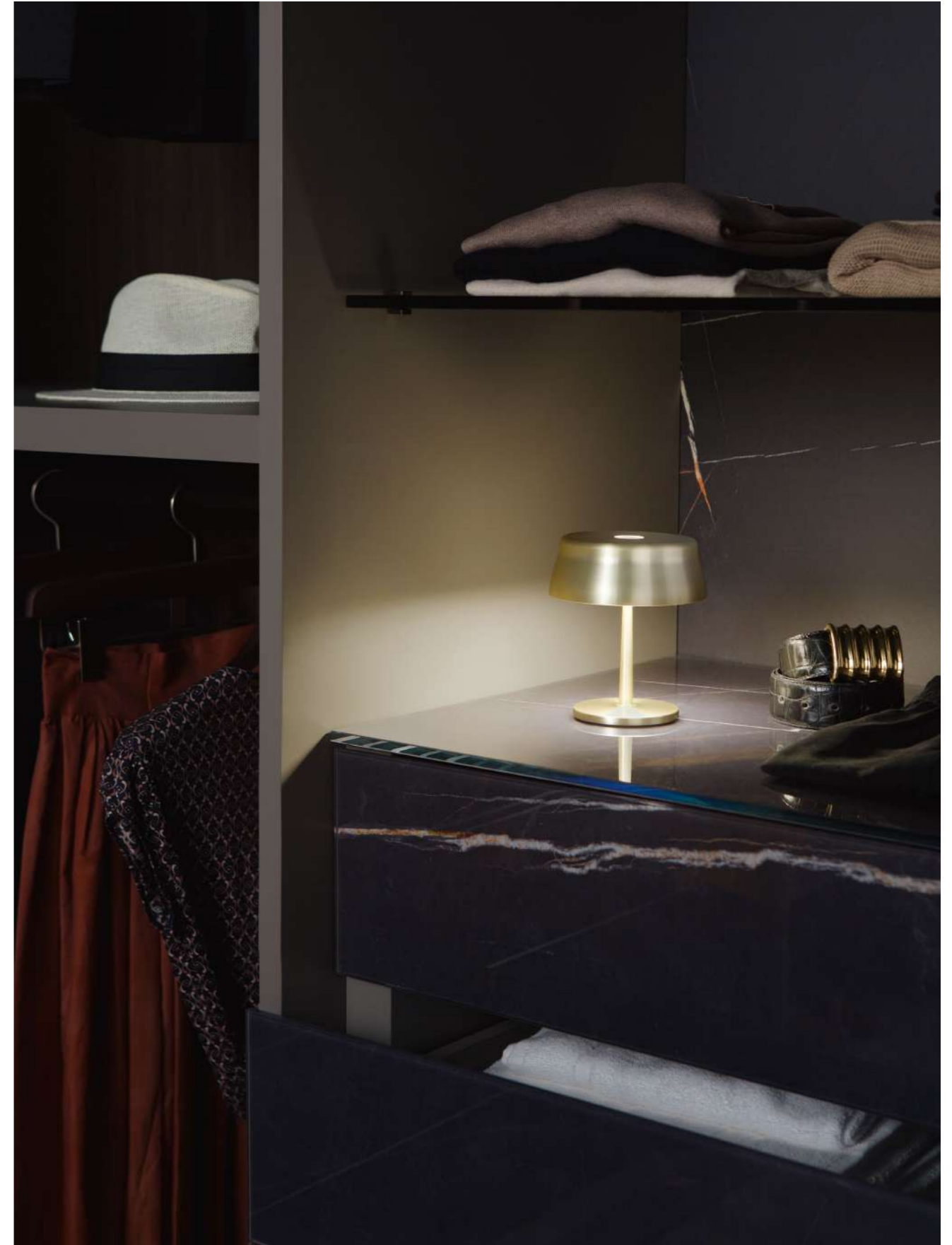

**Dati tecnici**

## Technical data

LED DIMMER • 3W • 250-260-270lm  
 2700-3150-4000K • IP65 • CRI>90  
 100-240V • 50-60Hz • 5Vdc max 2A

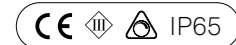

Pacco batteria al litio ricaricabile e sostituibile  
 Rechargeable and replaceable lithium battery pack

Durata 8 - 58 h, in base alla regolazione del flusso luminoso

Battery lasts 8 - 58 h, depending on the luminous flux setting.

Ricarica con cavetto USB-c  
 Rechargeable with a USB-c cable

Tempo di ricarica a 2A: circa 5 h  
 Charging time at 2A: about 5 h

Corpo in alluminio anodizzato  
 Anodized aluminium fixture

Diffusore in policarbonato prismatico  
 Prismatic polycarbonate diffuser

Adatta all'uso esterno (lampada IP65) e interno (lampada su base di ricarica IP20) → legenda pag. 178  
 Suitable for outdoor (lamp IP65) and indoor use (lamp on charging base IP20) → legend pg. 178

Resistenza agli urti (IK07) e alla nebbia salina (1500h)  
 Impact resistance (IK07) and salt spray resistance (1500h)

Ø 13,2 cm  
 Ø 5,2"

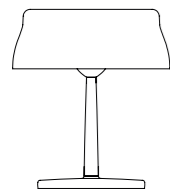

15 cm  
 5,9"

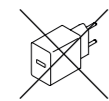

non incluso  
 not included



Ø 9 cm  
 Ø 3,5"

**Accessori inclusi**

Accessories included

Cavo di ricarica con entrata USB-c  
 Charging cable with USB-c input

Kit per fissaggio magnetico  
 Kit for magnetic fixing

Kit per fissaggio meccanico al tavolo  
 Kit for mechanical fixing to a table

**Accessori non inclusi**

Accessories not included

Caricatore  
 Charger

**Finiture**

## Finishes

**LD030603**

Oro  
 Gold

**LD0306R3**

Rame  
 Copper

**LD0306V3**

Verde  
 Green

# Sister Light mini

## Bowl/piatto

### Bowl/plate



Elemento contenitore da tavolo, composto dalla base della lampada Sister Light mini tavolo a cui è fissato magneticamente un accessorio in vetro borosilicato, disponibile in due varianti: bowl e piatto. La base dell'elemento è predisposta per il fissaggio meccanico al tavolo.

A serving accessory for the table, comprising the base of Sister Light mini table lamp magnetically attached to a borosilicate glass element, available in two versions: a bowl and a plate. The base of the accessory is designed to be mechanically fixed to a table.

### Dati tecnici

#### Technical data



Corpo in alluminio anodizzato  
Anodized aluminium fixture

Accessorio contenitore magnetico in vetro borosilicato  
Magnetic serving accessory in borosilicate glass

Resistenza alla nebbia salina (1500 h)  
Salt spray resistance (1500h)

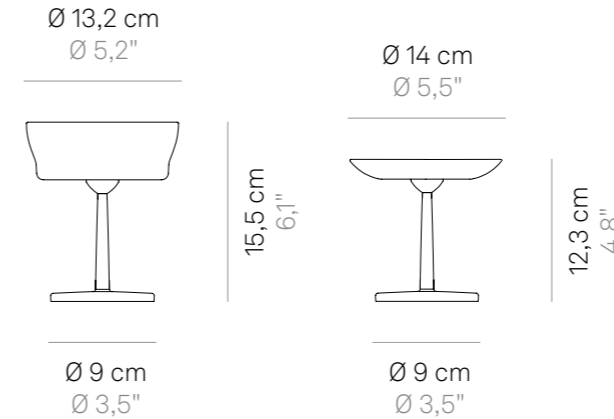

### Finiture

#### Finishes



**LD070003**  
Oro  
Gold



**LD0700R3**  
Rame  
Copper



**LD0700V3**  
Verde  
Green



### Finiture

#### Finishes



**LD070103**  
Oro  
Gold



**LD0701R3**  
Rame  
Copper



**LD0701V3**  
Verde  
Green



# Sister Light

## Picchetto

Lamp with peg



Sister Light picchetto è una lampada a batteria portatile e ricaricabile. È dotata di un sistema di controllo elettronico che monitora l'autonomia residua e garantisce un flusso luminoso costante fino all'esaurimento della batteria. Un menu touch multifunzione permette di regolare la temperatura di colore della luce tra 2700-3350-4000K (bianco dinamico) e impostare o escludere la dimmerazione a 4 step. La testa della lampada, fissata sullo stelo è convertibile a fissaggio magnetico e dunque può essere separata per diventare una fonte luminosa di emergenza. Dotata di un kit di 3 aste che permette di regolare l'altezza della lampada da un minimo di 58 a un massimo di 108 cm.

Sister Light lamp with peg is a battery-operated portable and rechargeable lamp. It is equipped with an electronic control system monitors the remaining autonomy and ensures constant luminous flux until the battery runs out. A customisable multifunctional touch control menu allows you to adjust the light color temperature to 2700-3350-4000K (dynamic white) and to set or exclude the 4-step dimmer function. The top of the lamp, magnetized on the stem (convertible to mechanical fixing), can be detached to become an emergency lamp. Equipped with a 3-rod kit that allows you to adjust the height of the lamp from minimum 58 cm to maximum 108 cm.

Sister Light lamp with peg green → **LD0302V3**  
Sister Light lamp with peg copper → **LD0302R3**



**Dati tecnici**

## Technical data

LED DIMMER • 3W • 250-260-270lm  
 2700-3150-4000K • IP65 • CRI>90  
 100-240V • 50-60Hz • 5Vdc max 2A

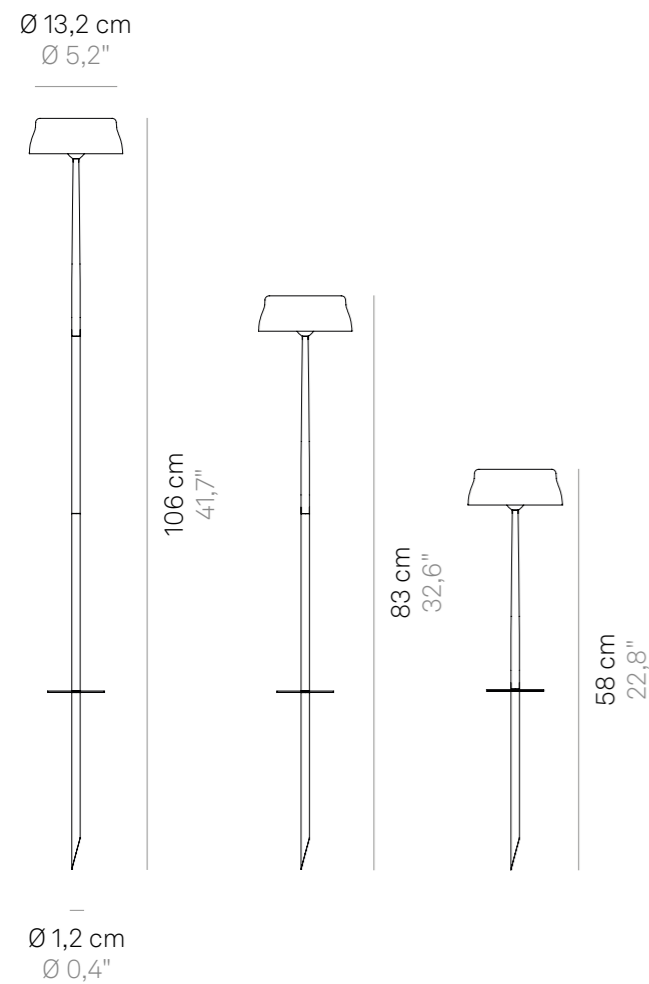
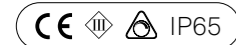

Pacco batteria al litio ricaricabile e sostituibile  
 Rechargeable and replaceable lithium battery pack

Durata 8 - 58 h, in base alla regolazione del flusso luminoso

Battery lasts 8 - 58 h, depending on the luminous flux setting.

Ricarica con cavetto USB-c  
 Rechargeable with a USB-c cable

Tempo di ricarica a 2A: circa 5 h  
 Charging time at 2A: about 5 h

Corpo in alluminio anodizzato  
 Anodized aluminium fixture

Diffusore in policarbonato prismatico  
 Prismatic polycarbonate diffuser

Adatta all'uso esterno (lampada IP65) e interno (lampada su base di ricarica IP20) → legenda pag. 178  
 Suitable for outdoor (lamp IP65) and indoor use (lamp on charging base IP20) → legend pg. 178

Resistenza agli urti (IK07) e alla nebbia salina (1500h)  
 Impact resistance (IK07) and salt spray resistance (1500h)

**Avvertenze**

## Remarks

La testa della lampada può essere svitata per avvicinarla a una fonte di alimentazione, facilitando l'operazione di ricarica.

The head can be removed from the body of the lamp for easier recharging.

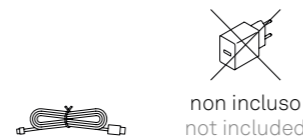
**Accessori inclusi**

## Accessories included

Cavo di ricarica con entrata USB-c  
 Charging cable with USB-c input

Kit per fissaggio magnetico  
 Kit for magnetic fixin

Kit di 3 aste  
 3-rod kit

**Accessori non inclusi**

## Accessories not included

Caricatore  
 Charger

**Finiture**

## Finishes

**LD0302R3**

Rame  
 Copper

**LD0302V3**

Verde  
 Green

# Sister Light

## Parete Wall lamp



Sister Light wall lamp  
copper → **LD0308R3**

Sister Light parete è una lampada a batteria portatile e ricaricabile. È dotata di un sistema di controllo elettronico che monitora l'autonomia residua e garantisce un flusso luminoso costante fino all'esaurimento della batteria. Un menu touch multifunzione di personalizzazione permette di regolare la temperatura di colore della luce tra 2700-3350-4000K (bianco dinamico) e impostare o escludere la dimmerazione a 4 step. La testa della lampada, calamitata sullo stelo (convertibile a fissaggio meccanico) può essere separata per diventare una fonte luminosa di emergenza.

Sister Light wall lamp is a battery-operated portable and rechargeable lamp. It is equipped with an electronic control system monitors the remaining autonomy and ensures constant luminous flux until the battery runs out. A customisable multifunctional touch control menu allows you to adjust the light colour temperature to 2700-3350-4000K (dynamic white) and to set or exclude the 4-step dimmer function. The top of the lamp, magnetized on the stem (convertible to mechanical fixing), can be detached to become an emergency light.



**Dati tecnici**

## Technical data

LED DIMMER • 3W • 250-260-270lm  
 2700-3150-4000K • IP65 • CRI>90  
 100-240V • 50-60Hz • 5Vdc max 2A

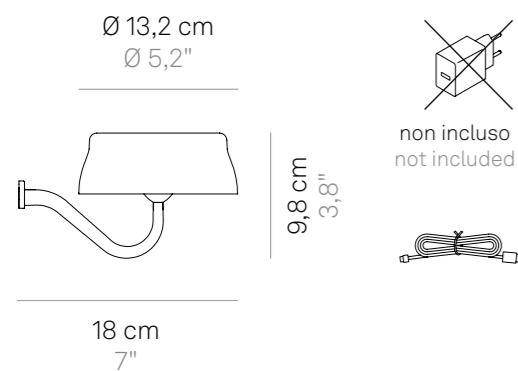
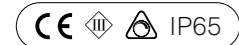

Pacco batteria al litio ricaricabile e sostituibile  
 Rechargeable and replaceable lithium battery pack

Durata 8 - 58 h, in base alla regolazione del flusso luminoso  
 Battery lasts 8 - 58 h, depending on the luminous flux setting.

Ricarica con cavetto USB-c  
 Rechargeable with a USB-c cable

Tempo di ricarica a 2A: circa 5 h  
 Charging time at 2A: about 5 h

Corpo in alluminio anodizzato  
 Anodized aluminium fixture

Diffusore in policarbonato prismatico  
 Prismatic polycarbonate diffuser

Adatta all'uso esterno (lampada IP65) e interno (lampada su base di ricarica IP20) → legenda pag. 178  
 Suitable for outdoor (lamp IP65) and indoor use (lamp on charging base IP20) → legend pg. 178

Resistenza agli urti (IK07) e alla nebbia salina (1500h)  
 Impact resistance (IK07) and salt spray resistance (1500h)

**Avvertenze**

## Remarks

La testa della lampada può essere svitata per avvicinarla a una fonte di alimentazione, facilitando l'operazione di ricarica.

The head can be removed from the body of the lamp for easier recharging.

**Accessori inclusi**

Accessories included

Cavo di ricarica con entrata USB-c  
 Charging cable with USB-c input

Kit per fissaggio magnetico  
 Kit for magnetic fixing

**Accessori non inclusi**

Accessories not included

Caricatore  
 Charger

**Finiture**

## Finishes

**LD0308R3**

Rame  
 Copper

**LD0308V3**

Verde  
 Green

# Pencil

Design Federico de Majo

Sospesa magicamente  
abbracciata o libera  
sembri sostenere il peso del tronco.  
Esile presenza  
ti presti a giocare  
in una luminosa danza.

Magically suspended  
embraced or free  
you appear to be bearing the weight of a trunk.  
Slender presence  
you play along  
in a luminous dance.

MODULO LUCE / CARICABATTERIE / BASE DI STAZIONAMENTO E RICARICA / BASE DI STAZIONAMENTO ROTANTE / SUPPORTI TAVOLO /  
SUPPORTI PARETE ORIZZONTALE / SUPPORTO PARETE VERTICALE / SUPPORTO SOSPENSIONE VERTICALE / SUPPORTI SOSPENSIONE  
ORIZZONTALE LIGHTING MODULE / BATTERY CHARGER / DOCKING AND CHARGING STATION / ROTATING DOCKING STATION / TABLE BASES  
/ HORIZONTAL WALL LAMP BRACKETS / VERTICAL WALL LAMP KIT / VERTICAL SUSPENSION KIT / HORIZONTAL SUSPENSION KIT



Pencil lighting module large white → **LD0802B3**  
Pencil lighting module medium white → **LD0801B3**  
Pencil lighting module small white → **LD0800B3**  
Cansiglio forest  
Treviso, Italy



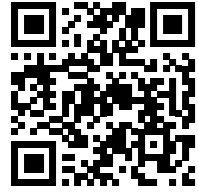

Video Pencil

Pencil è un modulo luminoso a batteria, portatile e ricaricabile, disponibile in tre misure, che grazie agli appositi accessori può diventare lampada da terra, tavolo, parete e a sospensione.

Dotato di sorgente luminosa a LED, Pencil produce una luce intensa e ben direzionata adatta a spazi pubblici e privati, anche outdoor (IP65).

La struttura, a sezione pentagonale, è in estrusione d'alluminio verniciato bianco, corten o grigio scuro; il diffusore è in policarbonato opale satinato.

Un dimmer touch a 4 steps permette di calibrare con precisione l'illuminazione di un ambiente, e di scegliere la temperatura di colore della luce tra 2700-3150-4000K (bianco dinamico).

Pencil può essere ricaricato in due modi: direttamente tramite caricatore (pagina 150); o a contatto sulla base di stazionamento, la quale può essere utilizzata anche solo come alloggio del modulo, per un utilizzo come lampada da terra o da tavolo (pagina 152).

Grazie alla scheda LED avanzata, un sistema di controllo elettronico monitora l'autonomia residua e garantisce un flusso luminoso costante fino all'esaurimento della batteria, permettendo di ottimizzare le ricariche ed effettuarle sempre in maniera corretta. La durata della batteria varia dalle 8h alle 58h, in base alla regolazione del flusso luminoso; i tempi di ricarica a 3,16A sono 6 ore per il modulo piccolo, 9 per il medio, 12 per il grande.

Pencil is a battery-operated portable and rechargeable lighting module, available in three sizes. Thanks to its dedicated accessories, it can become a floor, table, wall and suspension lamp. Equipped with a LED light source, Pencil creates an intense, well-directed light ideal for public and private spaces, also outdoors (IP65).

Its fixture, with a pentagonal cross-section, is made of white, corten or dark grey painted extruded aluminium. The diffuser is in satin opal polycarbonate.

Its 4-step dimmer touch control allows you to accurately adjust the lighting in a room and choose the light colour temperature, 2700-3150-4000K (dynamic white).

Pencil can be recharged in two ways: either with the battery charger (page 150) or in the docking station, connected to a battery charger (page 152).

Thanks to a state-of-the-art LED circuit board, an electronic control system monitors the remaining autonomy and ensures a constant luminous flux until the battery runs out. Recharging is therefore optimised and always properly done. The battery lasts 8h - 58h, depending on the luminous flux setting. At 3.16A, recharging times are 6h for the small module, 9h for the medium module and 12h for the large module.

Pencil lighting module large white  
+ docking station white  
→ **LD0802B3 + LD0810B3**  
Osteria Stasera Corder - Treviso, Italy  
Photo phEsci Francesco Esci



# Pencil

## Modulo luce

Lighting module



Pencil è un elemento luminoso a batteria portatile e ricaricabile, in tre misure, che grazie agli accessori dedicati può diventare lampada da terra, tavolo, parete e a sospensione. È dotato di: sistema di controllo elettronico che monitora l'autonomia residua e garantisce un flusso luminoso costante fino all'esaurimento della batteria, touch dimmer e della funzione di selezione della temperatura di colore della luce tra 2700-3150-4000K (bianco dinamico).

Pencil is a battery-operated portable and rechargeable lighting module, available in three sizes. Thanks to its dedicated accessories, it can become a floor, table, wall, and suspension lamp. It is equipped with: electronic control system that monitors the remaining autonomy and ensures constant luminous flux until the battery runs out, dimmer touch control and a light colour temperature selection function, 2700-3150-4000K (dynamic white).

Pencil lighting module medium white  
+ vertical suspension kit  
→ LD0801B3 + LD0811B3

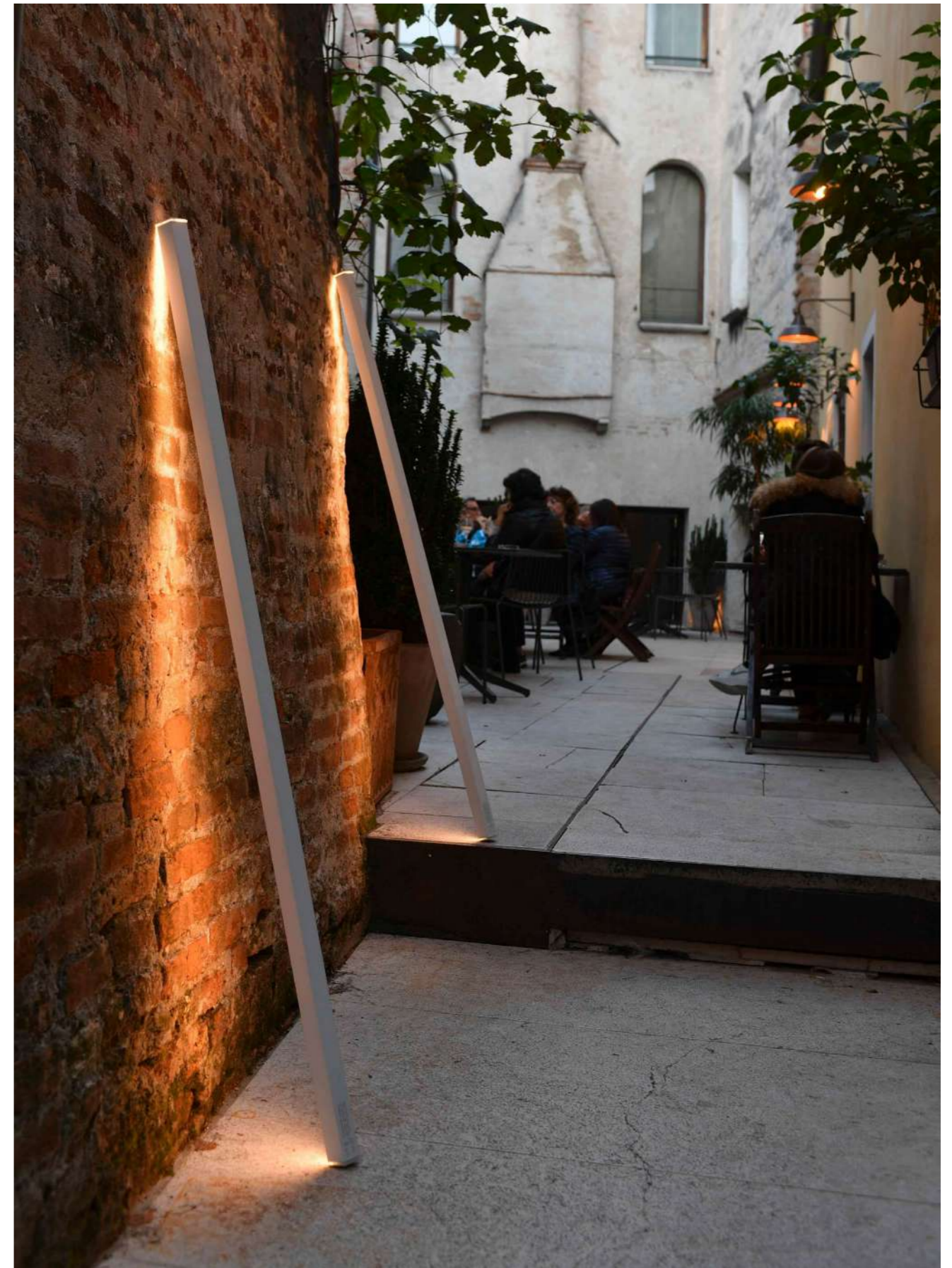

**Dati tecnici**

## Technical data

Small

LED DIMMER • 6W • 530-590-680lm  
2700-3150-4000K • IP65 • CRI>90  
100-240V • 50-60Hz • 19Vdc max 2,5A

Medium

LED DIMMER • 12W • 1050-1180-1350lm  
2700-3150-4000K • IP65 • CRI>90  
100-240V • 50-60Hz • 19Vdc max 2,5A

Large

LED DIMMER • 18W • 1340-1500-1700lm  
2700-3150-4000K • IP65 • CRI>90  
100-240V • 50-60Hz • 19Vdc max 2,5A

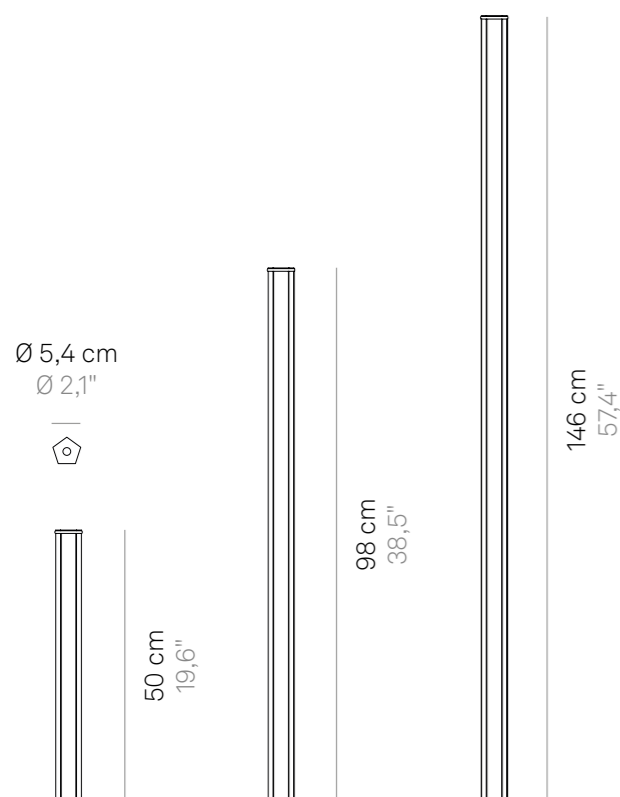

Pacchi batterie al litio ricaricabili e sostituibili  
Rechargeable and replaceable lithium battery packs

Durata 8 - 58 h, in base alla regolazione del flusso luminoso

Battery lasts 8 - 58 h, depending on the luminous flux setting.

Ricarica con connettore 3.5/1.3, oppure a contatto (quando usato su base ricarica)

Rechargeable with a 3.5/1.3 connector, or by contact (when used with the charging base)

Tempi di ricarica a 3,16A: 6/9/12 h (rispettivamente per misura piccola/media/grande)

Recharging times at 3.16A: 6/9/12 h (for small/medium/ large size respectively)

Corpo in estrusione d'alluminio verniciato  
Painted extruded aluminium fixture

Diffusore in policarbonato opale satinato  
Satin opal polycarbonate diffuser

Adatta all'uso esterno (lampada IP65) e interno (lampada su base di ricarica IP20) → legenda pag. 178

Suitable for outdoor (lamp IP65) and indoor use (lamp on charging base IP20) → legend pg. 178

Resistenza agli urti (IK07) e alla nebbia salina (1500h)  
Impact resistance (IK07) and salt spray resistance (1500h)

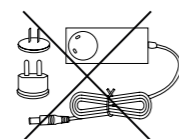

non incluso  
not included

**Non inclusi** → pag. 153

**Not included** → pg. 153

Caricabatterie con connettore 3.5/1.3 \*  
Charger with a 3.5/1.3 connector \*

\* Componente necessario, da acquistare separatamente  
\* Necessary component, yet it must be purchased separately

**Attenzione**

## Remarks

Con gli accessori dedicati, il modulo luminoso Pencil può diventare lampada da terra, tavolo, parete e a sospensione.  
Thanks to its dedicated accessories, the lighting module can become a floor, table, wall and pendant lamp.

**Finiture**

## Finishes



Bianco  
White  
RAL 9003

Corten

Grigio scuro  
Dark grey  
RAL 7012

Small

**LD0800B3**

**LD0800R3**

**LD0800G3**

Medium

**LD0801B3**

**LD0801R3**

**LD0801G3**

Large

**LD0802B3**

**LD0802R3**

**LD0802G3**

**Completa la tua lampada**

## Complete your lamp

Caricabatterie → pg. 150  
Battery charger → pg. 150

 Supporti parete orizzontale → pg. 158  
Horizontal wall lamp brackets → pg. 158

 Base di stazionamento e ricarica → pg. 152  
Docking and charging station → pg. 152

 Supporto parete verticale → pg. 160  
Vertical wall lamp kit → pg. 160

 Base di stazionamento rotante → pg. 154  
Rotating docking station → pg. 154

 Supporto sospensione verticale → pg. 162  
Vertical suspension kit → pg. 162

 Supporti tavolo → pg. 156  
Table bases → pg. 156

 Supporti sospensione orizzontale → pg. 166  
Horizontal suspension kit → pg. 166

# Pencil

## Caricabatterie Battery charger



### Dati tecnici Technical data

47,5W • 100-240V • 50-60Hz  
19Vdc max 2,5A

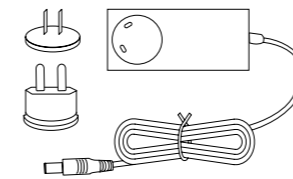

Caricabatterie con connettore 3.5/1.3  
Charger with a 3.5/1.3 connector

Spina intercambiabile per EU/USA in dotazione  
Interchangeable plug suitable for EU / USA standards

**LD0800CS**

Il caricabatterie permette di ricaricare Pencil in due modi: collegando il cavo (fig. 1) direttamente al modulo luminoso; oppure collegando il cavo alla docking station in cui il modulo viene posizionato (fig. 2). È un componente necessario, ma da acquistare separatamente: la lunga durata della batteria di Pencil consente infatti di utilizzare un solo caricabatterie per caricare più moduli. Ha una forma compatta, un cavo con attacco 3,5/1,3 e una spina intercambiabile per EU/USA in dotazione; funziona a 100-240 Volts.

The battery charger allows the recharging of Pencil in two ways: either by connecting cable directly to the lighting module (fig. 1); or by connecting the cable to the docking station where the module is placed (fig. 2). It is a necessary component, yet it must be purchased separately: the long-lasting battery of Pencil enables to use just one battery charger to charge multiple lighting modules. It has a compact design, a cable with 3.5/1.3 connection and an interchangeable plug suitable for EU / USA standards; dual voltage 100/240V.



# Pencil

## Base di stazionamento e ricarica\*

Docking and charging station\*

\* Solo se connesso al caricatore  
\* Only if connected with the charger



Accessorio con doppia funzione: è principalmente una base di stazionamento, che trasforma Pencil (pag. 146) in lampada da terra o da tavolo; collegato al caricabatterie (pag. 150), diventa una base di ricarica a contatto per il modulo luminoso. Il modulo luminoso può essere usato nel suo alloggiamento fisso, ma anche rimosso e portato con sé da un ambiente all'altro.

A dual-function accessory: it is mainly used as a docking station, turning Pencil (page 146) into a floor or table lamp. Connected to the battery charger (page 150), it becomes a contact charging base for the lighting module. The lighting module can be used in its fixed housing, or detached and carried from one place to another.

### Dati tecnici Technical data

19Vdc max 3,16A

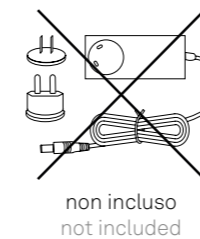
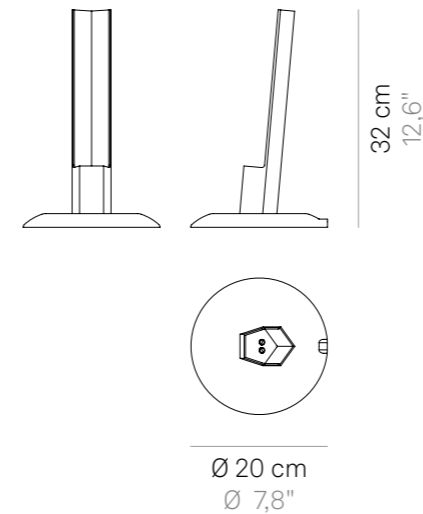

non incluso  
not included

Corpo in alluminio verniciato  
Painted aluminium fixture

Adatta all'uso interno (IP20) → legenda pag. 178  
Suitable for indoor use (IP20) → legend pag. 178

**Non inclusi** → pag. 153  
Not included → pg. 153

Caricabatterie con connettore 3.5/1.3  
Charger with a 3.5/1.3 connector



### Finiture Finishes



**LD0810B3**  
Bianco  
White  
RAL 9003



**LD0810R3**  
Corten



**LD0810G3**  
Grigio scuro  
Dark grey  
RAL 7012



# Pencil

## Base di stazionamento rotante

Rotating docking station



Base di stazionamento che trasforma Pencil (pag. 146) in lampada da terra o da tavolo. Rispetto alla base di stazionamento cod. LD0810B/R/G3 (pag. 152), questo accessorio mantiene il modulo luminoso in posizione perpendicolare rispetto al piano di appoggio, e ne permette la rotazione a 360° sull'asse longitudinale, in entrambi i sensi.

A seconda dell'orientamento, il modulo produce luce diretta o indiretta.

Il modulo luminoso può essere usato nel suo alloggiamento fisso, ma anche rimosso e portato con sé da un ambiente all'altro. Questa base di stazionamento non assolve la funzione di ricarica.

A docking station that turns Pencil (page 146) into a floor lamp or table lamp. In relation to the docking station, code LD0810B/R/G3 (page 152), this accessory keeps the lighting module in a perpendicular position in relation to the supporting surface, thereby allowing it to rotate 360° on the longitudinal axis, in both directions. Depending on the angle, the lighting module produces direct or indirect light.

The lighting module can also be used in its fixed housing, or detached and carried from one place to another.

This docking station does not provide a charging function.

### Dati tecnici Technical data



Corpo in alluminio verniciato  
Painted aluminium fixture

### Attenzione Remarks

Questa base di stazionamento non assolve la funzione di ricarica.  
This docking station does not provide a charging function.

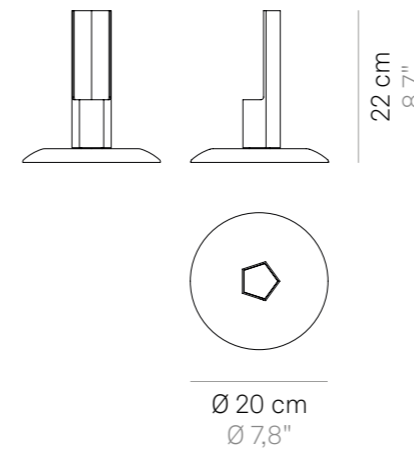

### Finiture Finishes



**LD0816B3**  
Bianco  
White  
RAL 9003



**LD0816R3**  
Corten



**LD0816G3**  
Grigio scuro  
Dark grey  
RAL 7012



# Pencil

## Supporti tavolo Table bases



### Dati tecnici Technical data

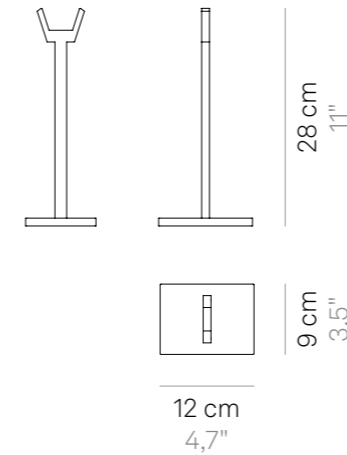

Supporti in PMMA trasparente  
Transparent PMMA structure



Elementi che trasformano Pencil (pag. 146) in una lampada da tavolo. A seconda della posizione in cui è appoggiata sulle staffe, il modulo produce luce diretta o indiretta. Il modulo luminoso può essere usato nel suo alloggiamento fisso, ma anche rimosso e portato con sé da un ambiente all'altro.

Elements that turn Pencil (page 146) into a table lamp. According to its position on the bases, it gives direct or indirect light. The lighting module can be used in its fixed housing, or detached and carried from one place to another.

### Finiture Finishes



**LD081400**  
Trasparente  
Transparent



# Pencil

## Supporti parete orizzontale Horizontal wall lamp brackets



Elementi che trasformano Pencil (pag. 146) in una lampada da parete orizzontale. A seconda della posizione in cui è appoggiato sui supporti, il modulo produce luce diretta o indiretta.

Il modulo luminoso può essere usato nel suo alloggiamento fisso, ma anche rimosso e portato con sé da un ambiente all'altro.

Elements that turn Pencil (page 146) into a horizontal wall lamp. Depending on the position where it is placed on supporting fixtures, the lighting module produces direct or indirect light.

The lighting module can also be used in its fixed housing, or detached and carried from one place to another.

### Dati tecnici Technical data

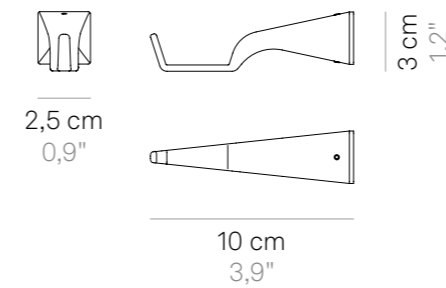

Supporti in pressofusione d'alluminio verniciato  
Painted die-cast aluminium elements



### Finiture Finishes



**LD0813B3**  
Bianco  
White  
RAL 9003



**LD0813R3**  
Corten



**LD0813G3**  
Grigio scuro  
Dark grey  
RAL 7012





# Pencil

## Supporto parete verticale Vertical wall lamp kit



Elemento che trasforma Pencil (pag. 146) in una lampada da parete verticale, che ruota sul proprio asse longitudinale a 360°, in entrambi i sensi. A seconda dell'orientamento, il modulo produce luce diretta o indiretta.

Il modulo luminoso può essere usato nel suo alloggiamento fisso, ma anche rimosso e portato con sé da un ambiente all'altro.

Element that turns Pencil (page 146) into a vertical wall lamp, rotating on its longitudinal axis by 360°, in both directions: according to its position, the module gives direct or indirect light. The lighting module can be used in its fixed housing, or detached and carried from one place to another.

### Dati tecnici Technical data

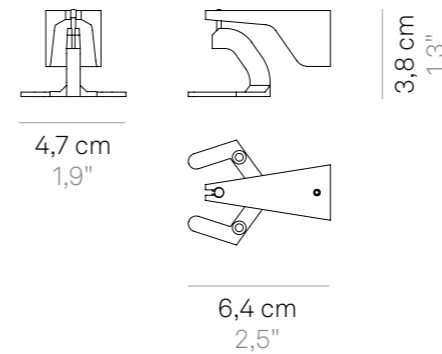

Supporto in pressofusione d'alluminio verniciato con particolari cromati  
Painted die-cast aluminium elements with chromed details



### Finiture Finishes



**LD0815B3**  
Bianco  
White  
RAL 9003



**LD0815R3**  
Corten



**LD0815G3**  
Grigio scuro  
Dark grey  
RAL 7012



# Pencil

## Supporto sospensione verticale

Vertical suspension kit



Elemento che trasforma Pencil (pag. 146) in una lampada a sospensione verticale. Il modulo luminoso può essere usato nel suo alloggiamento fisso, ma anche rimosso e portato con sé da un ambiente all'altro.

Element that turns Pencil (page 146) into a vertical suspension lamp. The lighting module can be used in its fixed housing, or detached and carried from one place to another.





Previous page: Pencil lighting module  
medium white + vertical suspension kit  
white → **LD0801B3 + LD0811B3**

Current page: Pencil lighting module  
medium white + vertical suspension kit  
white → **LD0801B3 + LD0811B3**

Pencil lighting module medium corten  
+ vertical suspension kit corten  
→ **LD0801R3 + LD0811R3**

Pencil lighting module medium dark grey  
+ vertical suspension kit dark grey  
→ **LD0801G3 + LD0811G3**

Pencil lighting module small dark grey  
+ battery charger → **LD0800G3 + LD0800CS**

## Dati tecnici

### Technical data

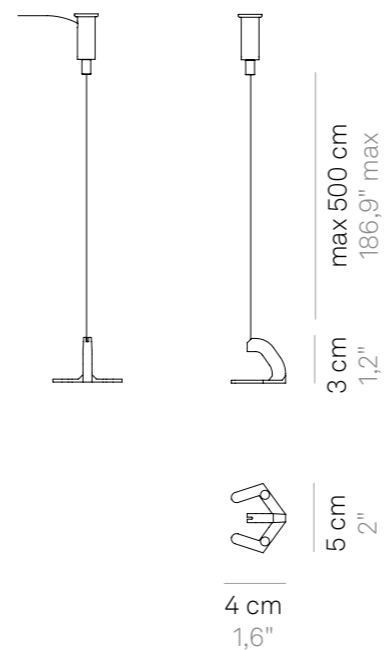

Supporto in pressofusione d'alluminio verniciato  
con particolari cromati  
Painted die-cast aluminium element with chromed  
details

### Accessori inclusi

#### Accessories included

Cavo in acciaio e staffe  
Steel cable and brackets



## Finiture

### Finishes



**LD0811B3**  
Bianco  
White  
RAL 9003



**LD0811R3**  
Corten



**LD0811G3**  
Grigio scuro  
Dark grey  
RAL 7014



# Pencil

## Supporti sospensione orizzontale

Horizontal suspension kit



Elementi che trasformano Pencil (pag. 146) in una lampada a sospensione orizzontale a luce diretta. Il modulo luminoso può essere usato nel suo alloggiamento fisso, ma anche rimosso e portato con sé da un ambiente all'altro.

Elements that turn Pencil (page 146) into a direct horizontal suspension lamp. The lighting module can be used in its fixed housing, or detached and carried from one place to another.

### Dati tecnici Technical data

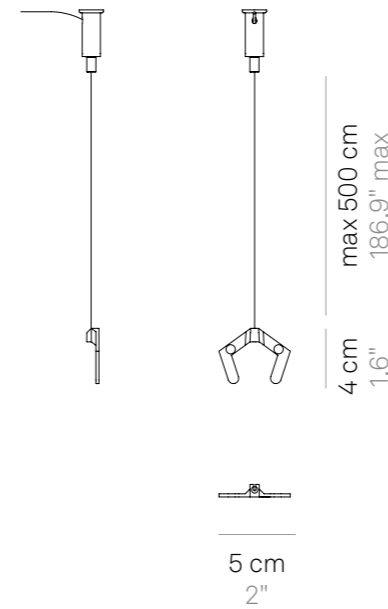

Supporto in pressofusione d'alluminio verniciato con particolari cromati  
Painted die-cast aluminium element with chromed details

### Accessori inclusi Accessories included

Cavo in acciaio e staffe  
Steel cable and brackets

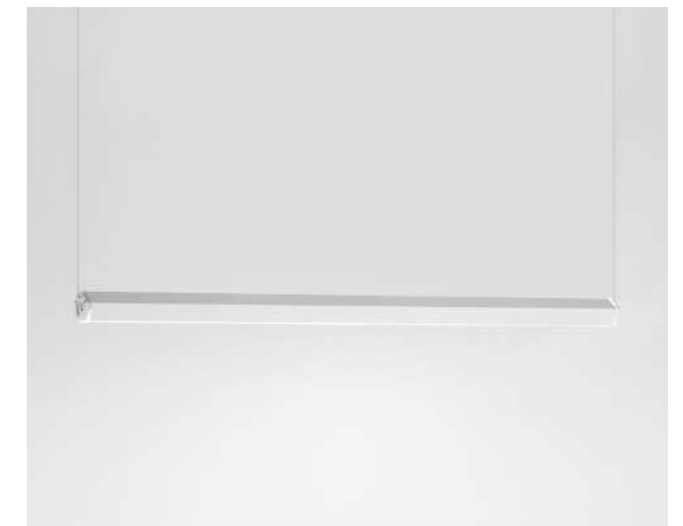

### Finiture Finishes



**LD0812B3**  
Bianco  
White  
RAL 9003



**LD0812R3**  
Corten



**LD0812G3**  
Grigio scuro  
Dark grey  
RAL 7014

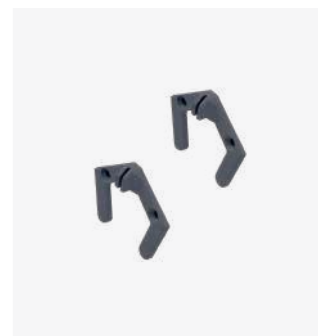

# Accessori

## Accessories



**LD0350RB**  
Base di ricarica a contatto  
(Poldina, Poldina mini)  
Contact charging base  
(Poldina, Poldina mini)



**LD0490RB**  
Base di ricarica a contatto  
(Poldina micro)  
Contact charging base  
(Poldina micro)



**LD0390RB**  
Base di ricarica a contatto  
(Poldina L)  
Contact charging base  
(Poldina L)



**LD0360RB**  
Base di ricarica a contatto  
(Poldina XXL)  
Contact charging base  
(Poldina XXL)



**LD0350RP**  
Base di ricarica a contatto multipla 6pz (Poldina, Poldina mini, Pina, Swap, Swap mini, Home, Dama, Olimpia)  
Multi-contact charging base 6pcs (Poldina, Poldina mini, Pina, Swap, Swap mini, Home, Dama, Olimpia)



**LD0490RP**  
Base di ricarica a contatto multipla 12pz (Poldina micro)  
Multi-contact charging base 12pcs (Poldina micro)



**LD0870RP**  
Base di ricarica a contatto multipla 6pz (Olivia, Olivia mini, Ofelia)  
Multi-contact charging base 6pcs (Olivia, Olivia mini, Ofelia)



**LD0340RA**  
Caricatore multipresa USB 8pz  
Multi-socket USB charger 8pcs



**LD0850RB**  
Base di ricarica a contatto (Olivia, Olivia mini)  
Contact charging base (Olivia, Olivia mini)



**LD0870RB**  
Base di ricarica a contatto (Ofelia)  
Contact charging base (Ofelia)



**LD0650RB**  
Base di ricarica a contatto (Pina)  
Contact charging base (Pina)

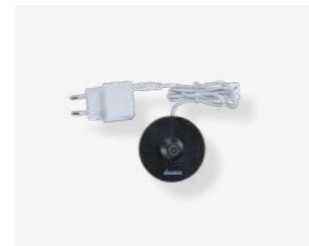

**LD0610RB**  
Base di ricarica a contatto (Dama USB)  
Contact charging base (Dama USB)



**LD0800CS**  
Caricabatterie con connettore 3.5/1.3 (pag. 150) (Pencil modulo luce, Pencil base ricarica)  
Charger with a 3.5/1.3 connector (page 150) (Pencil lighting module, Pencil charging base)



**LD0490UA**  
Caricabatterie con entrata USB (Poldina micro, Swap mini)  
USB port power charger (Poldina micro, Swap mini)



**LD0280UA**  
Caricabatterie con entrata Micro-USB (Poldina picchetto, Poldina sospensione, Poldina parete)  
Charger with Micro-USB input (Poldina lamp with peg, Poldina suspension lamp, Poldina wall lamp)



**CBL0420010000000**  
Cavo di ricarica con entrata USB-c (Sister Light)  
Charging cable with USB-c input (Sister Light)



**LD0900RB**  
Base di ricarica a contatto (Olimpia)  
Contact charging base (Olimpia)



**LD1010RB**  
Base di ricarica a contatto (Swap)  
Contact charging base (Swap)

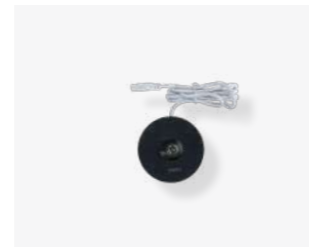

**LD1011RB**  
Base di ricarica a contatto (Swap mini)  
Contact charging base (Swap mini)



**LD0258RB**  
Base di ricarica a contatto (Home)  
Contact charging base (Home)



**LD0300KT**  
Kit per fissaggio meccanico al tavolo (Sister Light tavolo)  
Kit for mechanical fixing to a table (Sister Light table lamp)



**LD0300KN**  
Kit per fissaggio magnetico (Sister Light)  
Kit for magnetic fixing (Sister Light)



**LD0300KM**  
Kit per fissaggio meccanico (Sister Light)  
Kit for mechanical fixing (Sister Light)

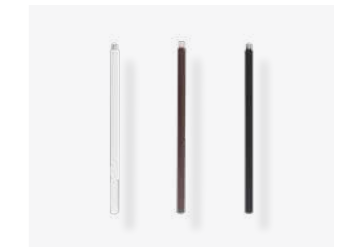

**LD0283B3**  
**LD0283R3**  
**LD0283N3**  
Prolunga stelo (Poldina picchetto)  
Stem extension (Poldina lamp with peg)

### Base di ricarica a contatto multipla (Poldina, Pina, Swap, Home, Dama, Olimpia) 6pz Multi-contact charging base (Poldina, Pina, Swap, Home, Dama, Olimpia) 6pcs

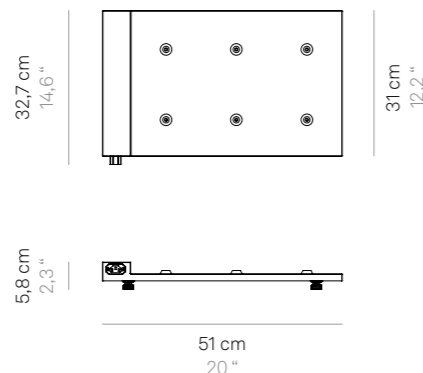

35W  
INPUT: AC 220-240V | 50-60Hz  
OUTPUT: 5Vdc - 5A (6 pcs.)

Base di ricarica a contatto multipla (max 6 pz.) e modulare: più basi possono essere collegate in sequenza per caricare contemporaneamente più lampade. Particolarmente adatto all'uso professionale.  
Modular multi-contact (max 6 pcs.) charging base: they can be connected in sequence to simultaneously charge multiple set of lamps. Particularly suitable for professional use.

→ LD0350RP

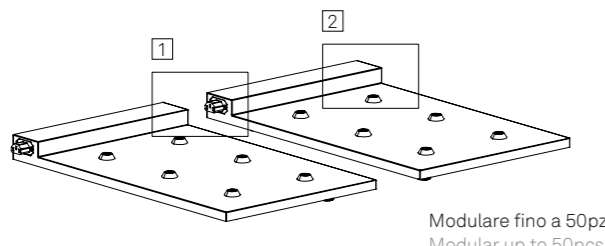
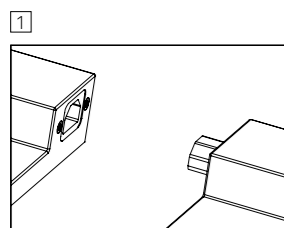

Modulare fino a 50pz  
Modular up to 50pcs

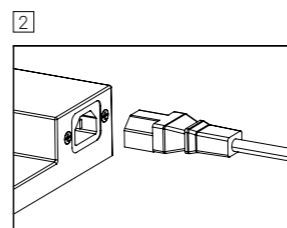

### Base di ricarica a contatto multipla (Poldina micro) 12pz Multi-contact charging base (Poldina micro) 12pcs

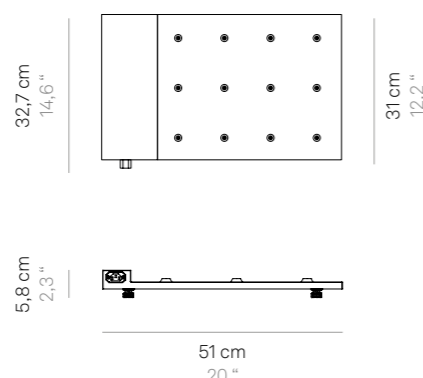

35W  
INPUT: AC 100-240V | 50-60Hz  
OUTPUT: 5Vdc - 5A (6 pcs.)

Base di ricarica a contatto multipla (max 12 pz.) e modulare: più basi possono essere collegate in sequenza per caricare contemporaneamente più lampade. Particolarmente adatto all'uso professionale.  
Modular multi-contact (max 12 pcs.) charging base: they can be connected in sequence to simultaneously charge multiple set of lamps. Particularly suitable for professional use.

→ LD0490RP

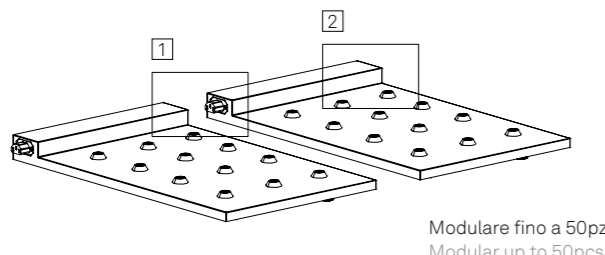
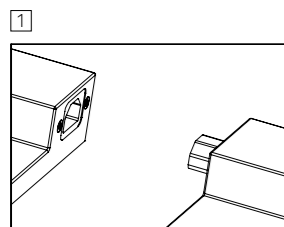

Modulare fino a 50pz  
Modular up to 50pcs

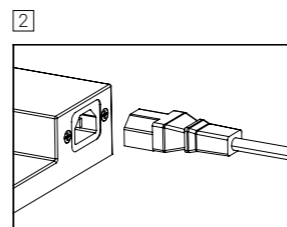

### Base di ricarica a contatto multipla (Olivia, Ofelia) 6pz Multi-contact charging base (Olivia, Ofelia) 6pcs

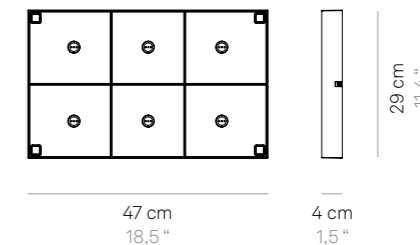

45W  
INPUT: AC 100-240V | 50-60Hz  
OUTPUT: 9Vdc

Base di ricarica a contatto multipla (max 6 pz.) e modulare: più basi possono essere impilate (fino a max 3 livelli) per caricare contemporaneamente più lampade. Particolarmente adatto all'uso professionale.  
Modular multi-contact (max 6 pcs.) charging base: they can be stacked (up to max 3 levels) to simultaneously charge multiple set of lamps. Particularly suitable for professional use.

→ LD0870RP

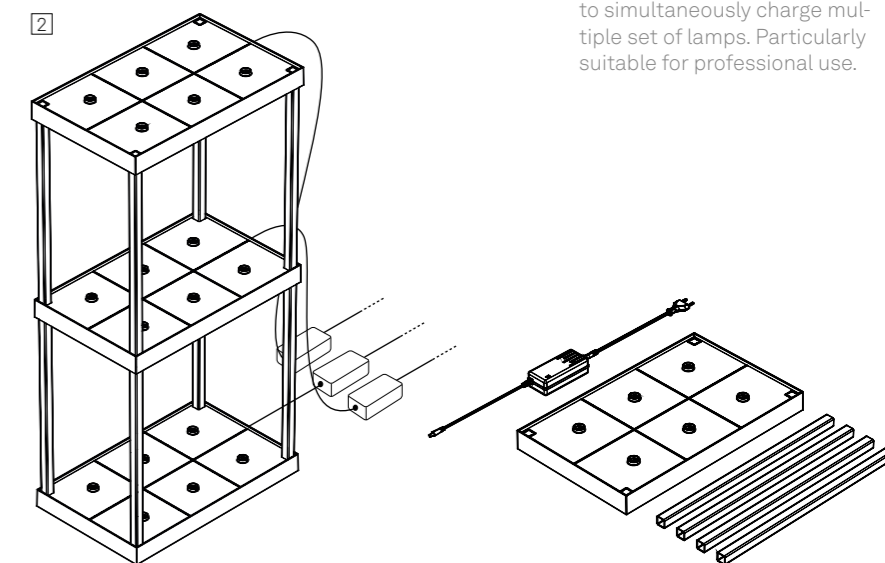
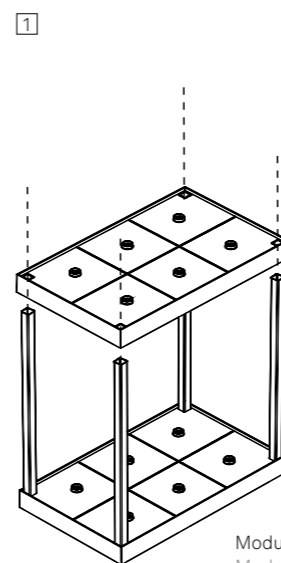

Modulare fino a 3 livelli.  
Modular up to 3 levels.

### Caricatore multipresa USB 8pz Multi-socket USB charger 8pcs

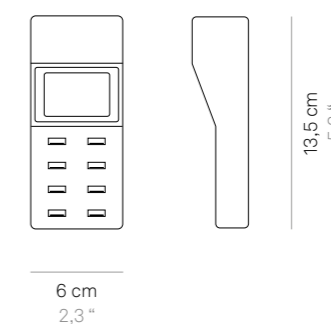

40W  
INPUT: AC 100-240V | 50-60Hz  
OUTPUT: 5Vdc - max 8A (8 pcs.)

Caricatore multipresa USB (8 x USB-A). Permette la carica di max 8 dispositivi contemporaneamente. Un display mostra graficamente il livello delle batterie in ricarica. Particolarmente adatto all'uso professionale.

USB multi-socket charger (8 x USB-A). Can charge of up to 8 devices simultaneously. A graphic display shows the level of the batteries being charged. Particularly suitable for professional use.

→ LD0340RA

## Batterie ricaricabili fatte

### Rechargeable batteries

Le batterie ricaricabili sono soggette ad usura. La vita delle batterie, il cui standard è di circa 450 ricariche, può essere ridotta da alcuni fattori come: ① la modalità non corretta di ricarica (la lampada va ricaricata quando è scarica: circa il 10% della sua autonomia residua); ② lunghi periodi di stazionamento senza utilizzo; ③ lunghi periodi di stazionamento su base di ricarica in tensione anche se la lampada risulta carica; ④ l'utilizzo di accessori non originali per la ricarica; ⑤ l'esposizione del prodotto a temperature molto alte o molto fredde. Quando le lampade non si ricaricano più o l'autonomia risulta molto ridotta, le batterie devono essere sostituite. I ricambi delle lampade ricaricabili Zafferano sono disponibili a catalogo e identificati con apposito codice. La garanzia sulle batterie è valida solo per difetti di fabbricazione, che si possono verificare dopo il primo utilizzo.

All rechargeable batteries are subject to wear when used. The life of batteries, which can generally be recharged 450 times, may be reduced by certain factors: ① incorrect recharging mode (the lamp must be recharged when it is flat: about 10% of its remaining autonomy); ② when left unused for a long time; ③ when left for a long time on a live recharging base even if the lamp is recharged; ④ when non-original accessories are used for recharging; ⑤ when the product is exposed to very high or very low temperatures. When the lamps no longer recharge or their autonomy after recharging is very short, the batteries must be replaced. Spare parts for Zafferano rechargeable lamps can be found in the catalogue and identified by a special code. The warranty for batteries is only valid for manufacturing defects, which may occur after initial use.

**BAT04701906701900**  
Pacco batteria sostitutiva  
singola (x 2 pz. **Pina tavolo;**  
**Home tavolo**  
x 3 pz. **Poldina L terra-tavolo**)  
Single replacement battery pack  
(x 2 pcs. **Pina table lamp; Home**  
**table lamp**  
x 3 pcs. **Poldina L floor-table lamp**)

3,7V | 1x2200mA/H



**BAT04704004001000**  
Pacco batteria sostitutiva  
singola (x 1 pz. **Poldina**  
**micro tavolo**)  
Single replacement battery  
pack (x 1 pcs. **Poldina**  
**micro table lamp**)

3,7V | 1x1900mA/H



**BAT04703706701900**  
Pacco batteria sostitutiva  
doppia (x 1 pz. **Poldina**  
**tavolo, Poldina mini tavolo,**  
**Poldina picchetto, Poldina**  
**sospensione, Poldina parete,**  
**Olivia, Ofelia, Dama, Olimpia;**  
x 3 pz. **Poldina XXL terra-**  
**tavolo**)  
Double replacement battery  
pack (x 1 pc. **Poldina table**  
**lamp, Poldina mini table**  
**lamp, Poldina lamp with peg,**  
**Poldina suspension lamp,**  
**Poldina wall lamp, Olivia,**  
**Ofelia, Dama, Olimpia;**  
x 3 pcs. **Poldina XXL floor-**  
**table lamp**)

3,7V | 2x2200mA/H



**BAT04701906701902**  
Pacco batteria sostitutiva  
singola (x 2 pz. **Swap tavolo,**  
**Swap tavolo mini**)  
Single replacement battery pack  
(x 2 pcs. **Swap table lamp, Swap**  
**mini table lamp**)

3,7V | 1x2600mA/H



**BAT04705506701900**  
Pacco batteria sostitutiva  
tripla  
(x 1 pz. **Sister Light**)  
Triple replacement  
battery pack  
(x 1 pc. **Sister Light**)

3,7V | 7500mA/H



**BAT04702719700300**  
Pacco batteria sostitutiva  
per **modulo Pencil piccolo**  
Replacement battery pack  
for **small Pencil module**

11,1V | 5000mA/H



**BAT04702739200600**  
Pacco batteria sostitutiva  
per **modulo Pencil medio**  
Replacement battery  
pack for **medium Pencil**  
**module**

11,1V | 10000mA/H



**BAT04702758700900**  
Pacco batteria sostitutiva  
per **modulo Pencil grande**  
Replacement battery  
pack for **large Pencil**  
**module**

11,1V | 15000mA/H

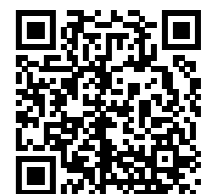

**Video tutorial:**  
sostituzione batterie  
**Tutorial video:**  
battery replacement

Cover in ceramica fatta a mano in Italia  
Handmade in Italy ceramic cover



**COV18213009010001**  
Righe verdi  
Green stripes  
(Poldina tavolo,  
Poldina mini tavolo.)  
(Poldina table lamp,  
Poldina mini table lamp)



**COV18113009010001**  
Righe gialle  
Yellow stripes  
(Poldina tavolo,  
Poldina mini tavolo.)  
(Poldina table lamp,  
Poldina mini table lamp)



**COV18213009010002**  
Righe blu  
Blue stripes  
(Poldina tavolo,  
Poldina mini tavolo.)  
(Poldina table lamp,  
Poldina mini table lamp)



**COV18113009010000**  
Righe rosse  
Red stripes  
(Poldina tavolo,  
Poldina mini tavolo.)  
(Poldina table lamp,  
Poldina mini table lamp)



**COV18213009010000**  
Pesci azzurri  
Light blue fish  
(Poldina tavolo,  
Poldina mini tavolo.)  
(Poldina table lamp,  
Poldina mini table lamp)

# Espositore Display unit

Espositore per lampade portatili Zafferano, realizzato in cartone stampato a colori su tutti i lati. Sul ripiano è possibile esporre una lampada (vincolabile tramite un cavo di sicurezza), la sua base di ricarica e/o i cataloghi della collezione.

La parte inferiore a giorno permette di alloggiare fino a 28\* scatole di lampade portatili. Il basamento dell'espositore, realizzato in legno, è dotato di quattro ruote piroettanti (di cui le due posteriori con freno), che rendono agile lo spostamento e sicuro lo stazionamento dell'espositore.

\* Quantità riferita ai modelli da tavolo Poldina, Olivia, Ofelia, Pina

Display unit for Zafferano cordless lamps, made of solid cardboard printed in color on all sides. On the shelf, it is possible to display a lamp (which can be secured with a safety cable), its charging base and / or the catalogs of the collection. The open lower part accommodates up to 28\* boxes of portable lamps. The display unit base, made of wood, is equipped with four swiveling wheels (two rear ones with brakes), for easy moving and secure parking.

\* This quantity refers to table lamps Poldina, Olivia, Ofelia, Pina

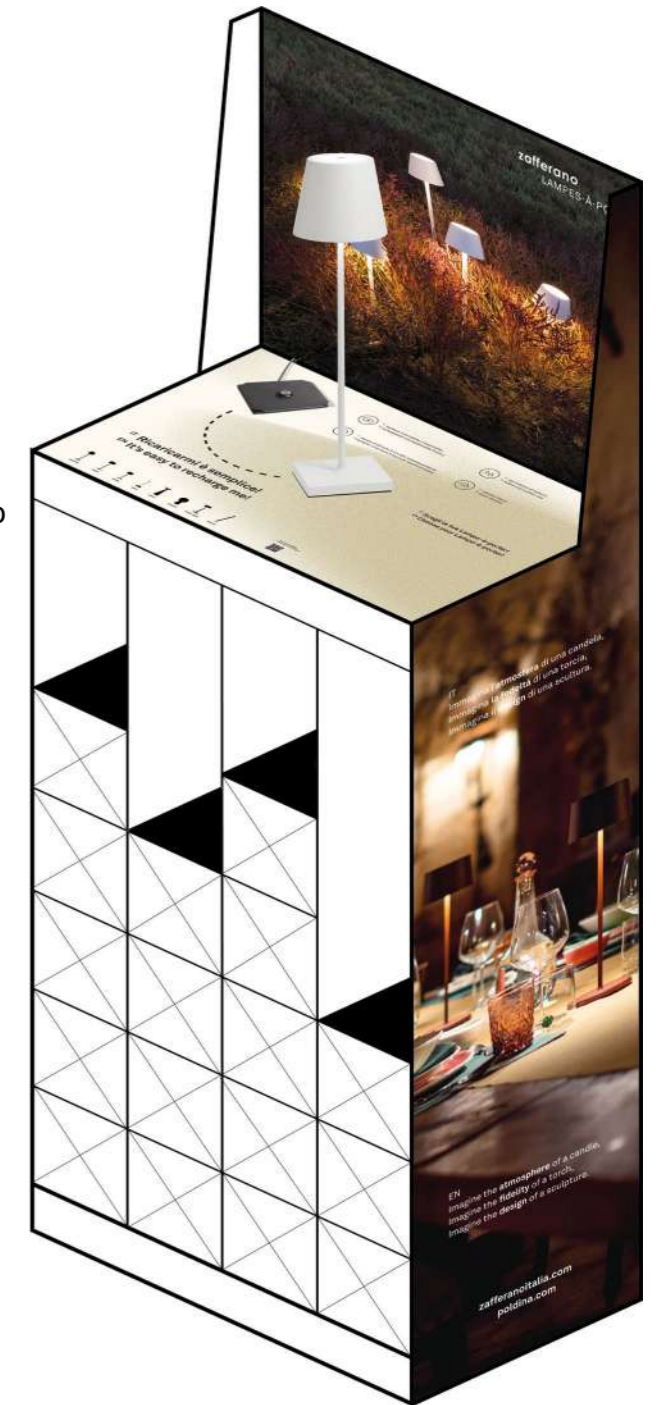



# Personalizzazione

## Customization

Su richiesta, con quantitativi minimi d'ordine, è possibile personalizzare le lampade con un servizio di logatura.

Available on request, with minimum ordering quantities, customised logo pad-printing service.



### Punti personalizzabili



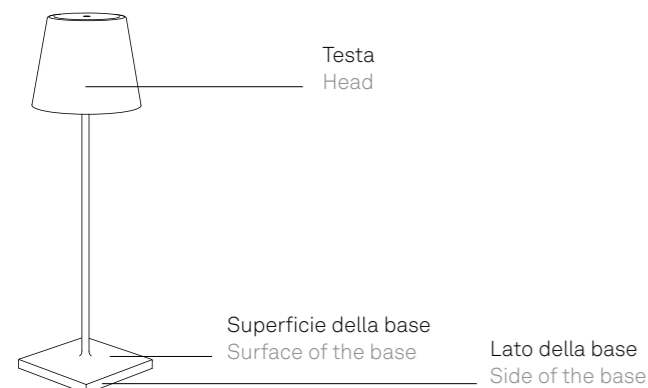

#### Customizable spots



# Indice per codice

## Code index

LD0258B3 LD0258R3 LD0258N3	pg. 100	LD0340A3 LD0340B3 LD0340BFA LD0340BFO LD0340C3 LD0340F3 LD0340G3 LD0340M3 LD0340N3 LD0340O3 LD0340P3 LD0340R3 LD0340RFR LD0340S3 LD0340X3	pg. 12	LD0611B3 LD0611N3	pg. 108	LD0816B3 LD0816R3 LD0816G3	pg. 154
LD0282B3 LD0282R3 LD0282N3	pg. 40	LD0288B3 LD0288N3 LD0288R3 LD0289B3 LD0289N3 LD0289R3	pg. 44	LD0650B3 LD0650D3 LD0650N3 LD0650R3 LD0650S3	pg. 76	LD0850B3 LD0850BFA LD0850BFO LD0850N3 LD0850R3 LD0850RFR	pg. 56
LD0288B3 LD0288N3 LD0288R3 LD0289B3 LD0289N3 LD0289R3	pg. 48	LD0300A3 LD0300B3 LD0300O3 LD0300R3 LD0300V3	pg. 124	LD0700O3 LD0700R3 LD0700V3 LD0701O3 LD0701R3 LD0701V3	pg. 132	LD0860B3 LD0860K3 LD0860L3 LD0860N3 LD0860R3 LD0860V3 LD0860Z3	pg. 60
LD0302R3 LD0302V3	pg. 134	LD0340AC1 LD0340BC1 LD0340BC2 LD0340BC3 LD0340FC1	pg. 16	LD0800CS	pg. 150		
LD0306O3 LD0306R3 LD0306V3	pg. 128	LD0340BP2 LD0340BP3 LD0340BP4 LD0340FP1 LD0340RP5	pg. 20	LD0800B3 LD0800R3 LD0800G3 LD0801B3 LD0801R3 LD0801G3 LD0802B3 LD0802R3 LD0802G3	pg. 146	LD0870B3 LD0870G3 LD0870N3 LD0870R3 LD0870S3	pg. 68
LD0308R3 LD0308V3	pg. 138	LD0360B3 LD0360N3 LD0360R3	pg. 36	LD0900B3 LD0900C3 LD0900E3 LD0900N3 LD0900O3	pg. 152	LD1010B3 LD1010N3 LD1010R3	pg. 86
LD0320B3 LD0320BFA LD0320BFO LD0320C3 LD0320N3 LD0320O3 LD0320R3 LD0320RFR LD0320S3	pg. 24	LD0390B3 LD0390N3 LD0390R3	pg. 32	LD0810B3 LD0810R3 LD0810G3	pg. 152	LD1020B3 LD1020N3 LD1020R3	pg. 86
		LD0490B3 LD0490C3 LD0490D3 LD0490F3 LD0490G3 LD0490K3 LD0490L3 LD0490N3 LD0490O3 LD0490P3 LD0490R3 LD0490S3 LD0490V3 LD0490Z3	pg. 28	LD0811B3 LD0811R3 LD0811G3	pg. 164	LD102000	pg. 90
				LD0812B3 LD0812R3 LD0812G3	pg. 166	LD102001 LD102002 LD102003 LD102004 LD102011 LD102012 LD102013 LD102014	pg. 92
				LD0813B3 LD0813R3 LD0813G3	pg. 158		
				LD081400	pg. 156		
						LD1020B3 LD1020N3 LD1020R3	pg. 86

<p><b>CE</b></p> <p>CE Dichiara che il prodotto soddisfa gli standard dell'UE per la salute, la sicurezza e la protezione ambientale. Declares that the product meets EU standards for health, safety, and environmental protection.</p>	<p></p> <p>CLASS II Apparecchio dotato di doppio isolamento e/o isolamento rinforzato in ogni parte e senza dispositivo di messa a terra. Light fitting equipped with double isolation and/or isolation reinforced in every part and without earthing device.</p>	<p></p> <p>CLASS III Apparecchio basato su un'alimentazione a bassissima tensione di sicurezza, in cui non si producono tensioni superiori alla stessa. Light fitting based on a very low safety voltage power supply, in which no tensions higher than the same are produced.</p>	<p>IP</p> <p>IP PROTECTION DEGREE IP20: apparecchio protetto dalla penetrazione di corpi solidi di dimensioni maggiori a 12mm e non protetto dai liquidi. IP54: apparecchio protetto da polveri e da spruzzi d'acqua. IP65: apparecchio fortemente protetto da polveri e da getti d'acqua. IP20: protected from the penetration of solid objects greater than 12 mm and non protected from liquids. IP54: protected from dust and splashing water. IP65: highly protected from dust and water jets.</p>
<p></p> <p>DIMMABLE Indica che è possibile regolare l'intensità luminosa della lampada. Indicates that the light intensity of the lamp can be adjusted.</p>	<p></p> <p>INDOOR Identifica un prodotto con apparecchiature elettriche progettate principalmente per uso interno. Identifies a product with electrical equipment designed primarily for indoor use.</p>	<p></p> <p>OUTDOOR Identifica un prodotto con apparecchiature elettriche progettate sia per uso interno che esterno. Identifies a product with electrical equipment designed both for indoor and outdoor use.</p>	

Headquarters  
**Zafferano SRL**  
Viale dell'industria 26  
31055 Quinto di Treviso (TV), Italy  
T +39 0422 470507  
F +39 0422 470400  
vendite@zafferanoitalia.com

Subsidiary  
**Zafferano America LLC**  
301 Penhorn Avenue  
Suite 5,  
Secaucus, NJ 07094  
T +1 888 744 5277  
info@zafferanoamerica.com

Showrooms  
**Zafferano Store Milano**  
Via Fatebenefratelli, 23  
Milan (Italy)  
**Zafferano Store Treviso**  
Viale dell'Industria, 26  
Quinto di Treviso (Italy)

Art Direction, Graphic Design  
Zafferano Design

Photography  
Claudio Mainardi  
Alberto Sinigaglia  
Quasar

Poems  
Federico de Majo

©2022 Peanuts Worldwide LLC  
www.peanuts.com

Printing  
L'Artegrafica  
May 2022

Acknowledgements  
Porto Caleri, Rovigo  
Caglieron Caves, Treviso  
Storga river springs, Treviso  
Morgano countryside, Treviso  
Piave riverbed, Treviso  
Brent de l'Art, Belluno  
Rosolina pine forest, Rovigo  
Cansiglio forest, Treviso  
Euganean hills, Padua  
(Italy)

Lago Design, Villa del Conte  
Padua, Italy

L'azienda si riserva di apportare modifiche e/o migliorie di carattere tecnico ed estetico ai propri modelli e prodotti in qualsiasi momento e senza preavviso.  
The company reserves the right to make modifications and improvements of a technical or aesthetic nature to the products at any time without notice.

Il prodotto è protetto da garanzia, a norma di legge.  
The product is covered by a warranty, according to the law.

© Copyright Zafferano SRL

CATLAP22-05

zafferanoitalia.com  
zafferanoamerica.com  
poldina.com

**zafferano**  
LAMPES-À-PORTER